

# STOCK MOULDINGS CATALOG



OLD FASHIONED LUMBER YARD WITH OLD FASHIONED SERVICE SINCE 1930  
2600 NW Market Street | Seattle, Wa 98107  
(206) 782-3487

# TABLE OF CONTENTS

TRIM.....	3
CASING.....	5
BASE.....	7
COVE.....	9
CROWN.....	10
BED MOULD.....	11
CHAIR RAIL & BATTEN.....	12
PICTURE RAIL.....	12
BRICK MOULD.....	13
CORNICE.....	13
CAP MOULD.....	14
BACKBAND.....	14
RAILINGS.....	15
STOOL & NOSING.....	16
FLOORING & MISC.....	17
RAKE MOULD.....	17
EXTERIOR APPLICATION.....	18

## HOW TO READ THIS CATALOG

This section is for customers who are browsing the mouldings we keep in stock at our yard. We specialize in many older style homes as well as contemporary. If you are looking to match something this is an excellent place to start as we have dozens of profiles to choose from for many applications, whether trying to match existing or installing new.

This catalog can be printed online or you can pick up a physical copy in our hardware store as well as view all the physical samples. If need be, you can print a single page from our online catalog to quickly match up profile and dimension from your home or office. Be sure to set your printer to "Print Actual Size" to get a better scale. While these side profiles are to scale please note they are not perfect. Ideally you would want to match up physical samples to each other for best comparison.

Our profiles are broken down into categories of style and application. Please refer to the table of contents to quickly find your specific profile. These profiles come in a variety of species including Hemlock, MDF, Poplar, Cedar, Finger Jointed Primed Pine, Douglas Fir, Mahogany, and Red Oak.

The species that these profile come in is listed next to each side profile as well as the dimension. If it comes in multiple species it will be listed as such. Please note we only stock the species listed for each profile, however, these profiles can be made in different species. Also, in the MDF and F/J Primed mouldings every so often supply cannot keep up with demand, in the event that our suppliers cannot get our usual profile we will source from another vendor. However, profile and dimension may differ slightly.

Questions about lengths, quantities, special ordering different species, or are ready to place an order please call, email, or come in person to talk to an associate. Reference the name, style, or moulding code to our sales staff so we can better assist you.

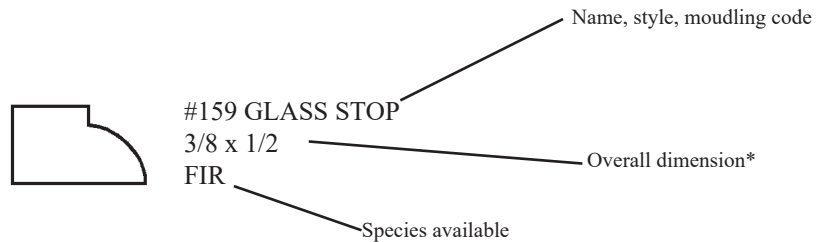

\*+/- 1/32" on overall dimension

**Contacts:**  
 (206) 782-3487  
[sales@limbacklumber.com](mailto:sales@limbacklumber.com)

# TRIM

## FIR, HEMLOCK, & MAHOGANY



SCREEN MOULD  
1/4 x 3/4  
HEMLOCK,  
MAHOGANY,  
MAPLE &  
RED OAK



ALICIA MOULD  
5/8  
FIR

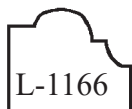

GLASS BEAD  
1/2 X 5/8  
FIR



#155 GLASS BEAD  
3/8 x 7/16  
FIR



#046 GLASS BEAD  
5/8  
HEMLOCK



#151 BEVEL STOP  
7/16 x 9/16  
FIR



#159 GLASS STOP  
3/8 x 1/2  
FIR



OG STOP  
5/8 x 7/8  
FIR



OG STOP  
7/16 x 1-3/8  
HEMLOCK

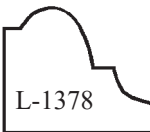

BASE CAP  
5/8 x 3/4  
HEMLOCK

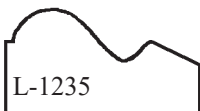

BASE CAP  
1/2 x 1  
HEMLOCK

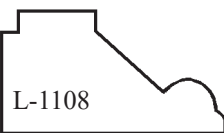

BASE CAP  
5/8 x 1-1/16  
FIR

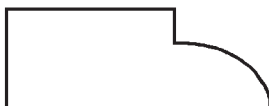

OG BASE SHOE  
1/2 x 1-3/8  
FIR



BASE CAP  
11/16 x 1-3/8  
FIR

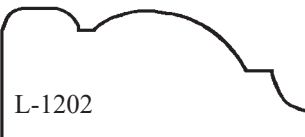

OG BASE CAP  
5/8 x 1-5/8  
FIR

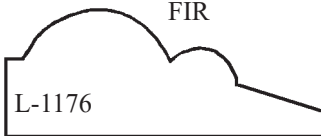

BEVEL BASE CAP  
5/8 x 1-5/8  
FIR



B/N STOP  
1/2 x 7/8  
HEMLOCK



B/N STOP  
1/2 x 1-1/16  
HEMLOCK



B/N STOP  
1/2 x 1-3/8  
HEMLOCK



B/N STOP  
1/2 x 1-5/8  
HEMLOCK



B/N STOP  
1/2 x 2-1/4  
HEMLOCK



LATTICE  
5/16 x 1-1/16  
HEMLOCK



LATTICE  
5/6 x 1-5/16  
HEMLOCK



LATTICE  
5/16 x 1-5/8  
HEMLOCK



LATTICE  
5/16 x 2-1/8  
HEMLOCK

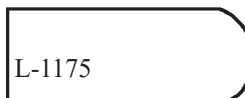

FILLET  
7/16 x 1-1/4  
FIR & F/J PRIMED



BASE CAP  
3/4 x 1-3/4  
POPLAR



B/N STOP  
3/8 x 1-1/4  
MAHOGANY



B/N STOP  
3/8 x 1-11/16  
MAHOGANY

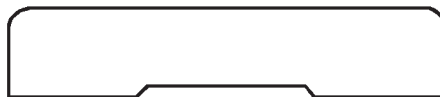

B/N STOP  
7/16 x 2-1/4  
RED OAK

# TRIM

## PANEL CAPS HEMLOCK

5/8 x 1-3/8  
H-291



3/4 x 2  
H-293

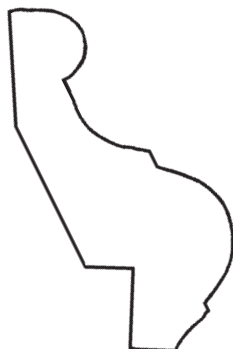

3/4 CANT STRIP  
KNOTTY PINE

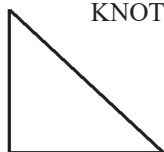

\*ALSO AVAILABLE IN  
UTILITY GRADE FIR/CEDAR  
3-1/2 CANT STRIP\*

## WAINSCOT CAPS HEMLOCK

1-1/8

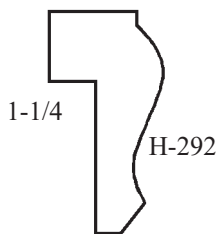

1-1/4

H-292

1-1/2 CANT STRIP  
KNOTTY PINE

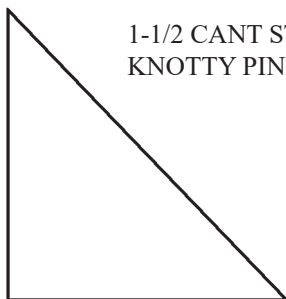

## OUTSIDE CORNER HEMLOCK & MAHOGANY

H-206



1/2" Inside measure  
3/4" Outside measure

H-205



3/4" Inside measure  
1" Outside measure

H-204

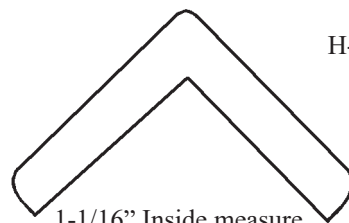

1-1/16" Inside measure  
1-5/16" Outside measure  
\*NO MAHOGANY

## QUARTER ROUND HEMLOCK



1/4



3/8

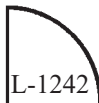

L-1242

1/2

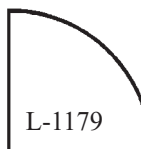

L-1179

3/4  
HEMLOCK,  
F/J PRIMED,  
MAHOGANY  
& RED OAK

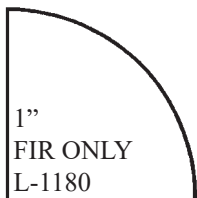

1"  
FIR ONLY  
L-1180

## SQUARE HEMLOCK



11/16

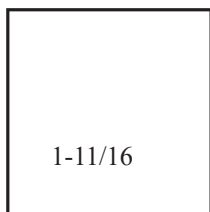

1-11/16

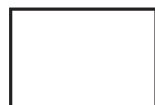

1/2 X 3/4  
PARTING BEAD



3/4  
RED OAK

## HALF ROUND HEMLOCK



1/2

L-1142 & H-124

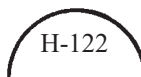

H-122

3/4

L-1236

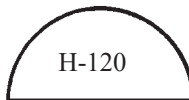

H-120

1"

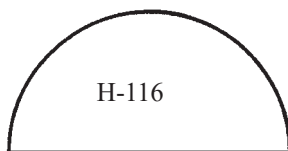

H-116

1-1/2

L-1115

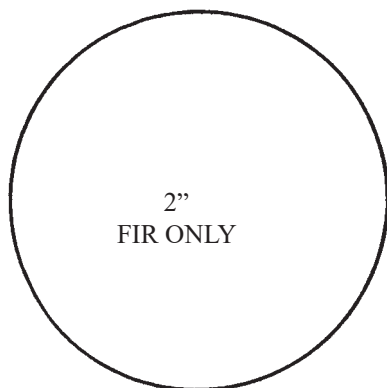

2"  
FIR ONLY

## FULL ROUNDS HEMLOCK



H-235

3/4

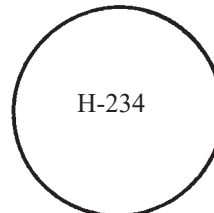

H-234

1-1/16

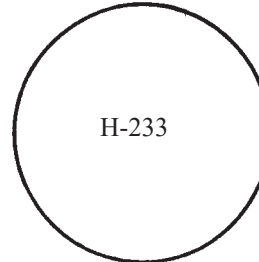

H-233

1-5/16  
TYPICAL  
CLOSET ROD

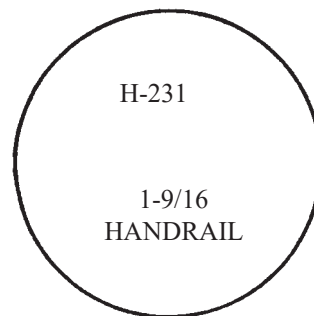

H-231

1-9/16  
HANDRAIL

# CASING

## FIR, HEMLOCK, & F/J PRIMED, & MDF

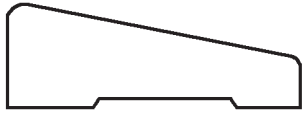

WEDGE  
1/2 x 1-1/2  
HEMLOCK

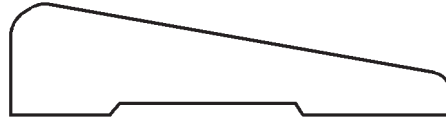

WEDGE  
1/2 x 2-1/4  
HEMLOCK

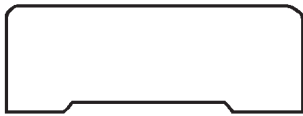

BULL NOSED  
1/2 x 1-1/2  
HEMLOCK



BULL NOSED  
1/2 x 2-1/4  
HEMLOCK &  
F/J PRIMED

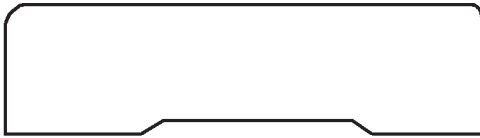

BULL NOSED  
11/16 x 2-1/2  
VG HEM & VG FIR



BULL NOSED  
11/16 x 3-1/2  
VG FIR & VG HEM



BULL NOSED  
5/8 x 2-1/4  
MDF



BULLNOSED  
11/16 x 3-1/2  
F/J PRIMED

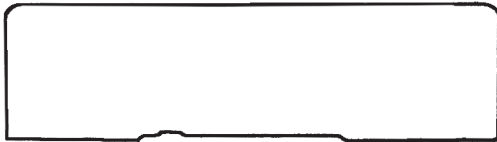

BULL NOSED  
11/16 x 2-1/2  
F/J PRIMED



BULLNOSED  
7/16 x 2-1/4  
RED OAK

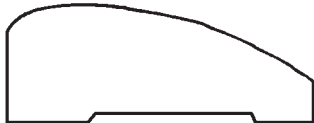

STREAMLINE  
1/2 x 1-5/8  
HEMLOCK

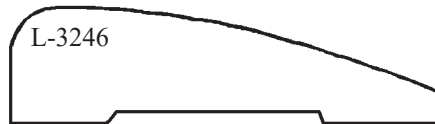

L-3246  
STREAMLINE  
1/2 x 2-1/4  
HEMLOCK

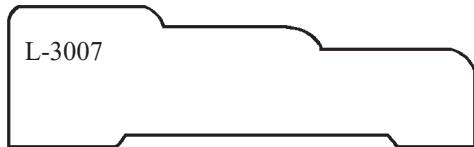

L-3007  
MOULDED  
5/8 x 2-3/8  
POPLAR

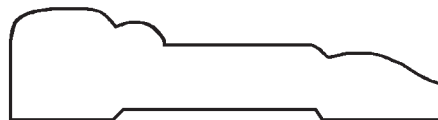

MOULDED  
9/16 x 2-1/4  
HEMLOCK

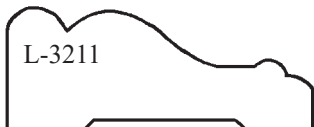

L-3211  
BEADED  
1/2 x 1-1/2  
HEMLOCK

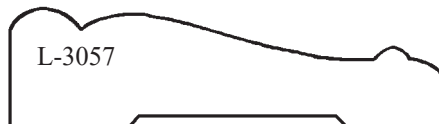

L-3057  
BEADED  
1/2 x 2-1/4  
HEMLOCK



L-3031  
FULL DIMENSION  
BEADED  
3/4 x 2-1/2  
VG FIR & POPLAR



BEADED  
9/16 x 2-1/2  
HEMLOCK

# CASING

## FIR, HEMLOCK, & F/J PRIMED

STEP  
3/4 x 3-1/2  
VG FIR & POPLAR

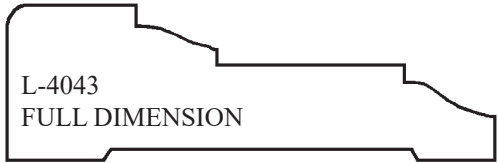

STEP  
3/4 x 2-1/2  
VG FIR &  
POPLAR

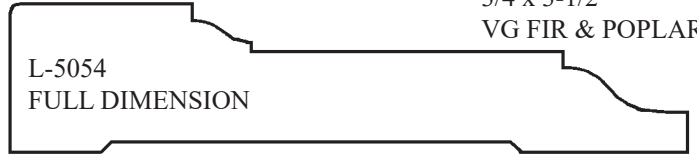

L-2133 MULLION MATCHES THE OG ON  
THE NOSE OF THIS PROFILE

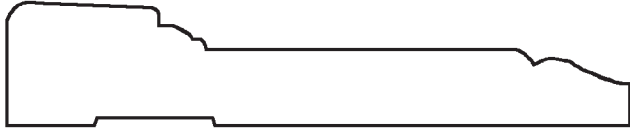

STEP MP-150  
5/8 x 3-1/4  
F/J PRIMED

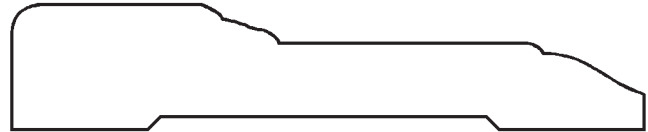

STEP  
5/8 x 3-3/8  
HEMLOCK

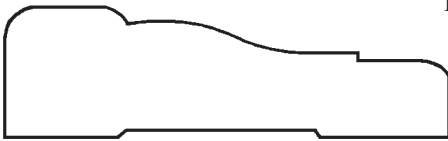

COLONIAL  
11/16 x 2-1/4  
HEMLOCK

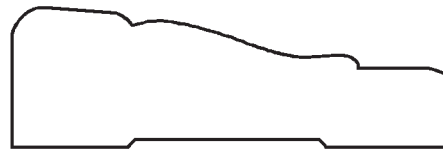

COLONIAL  
11/16 x 2-1/4  
VG FIR

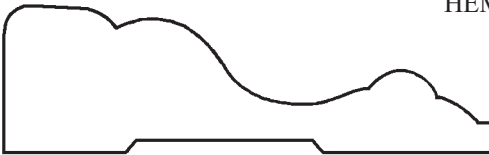

UNIVERSAL  
11/16 x 2-1/2  
HEMLOCK



CALLYPSO  
3/4 x 2-1/2  
POPLAR



COLONIAL  
7/16 x 3-1/4  
F/J PRIMED



WEDGE  
7/16 x 1-1/2  
MAHOGANY

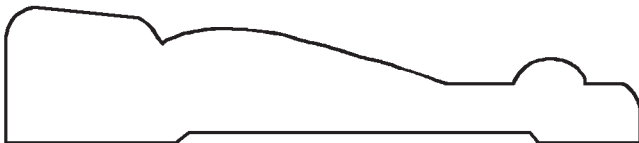

BEADED  
5/8 x 3-1/4  
HEMLOCK

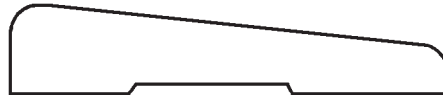

WEDGE  
7/16 x 2-1/4  
MAHOGANY

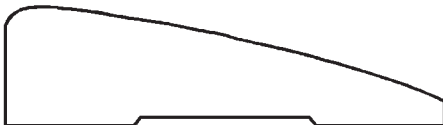

STREAMLINE  
5/8 x 2-1/4  
MAHOGANY

# BASEBOARD

FIR, HEMLOCK, MDF, F/J PRIMED, & MAHOGANY



BASE SHOE  
1/2 x 3/4  
HEMLOCK, FIR, MAHOGANY, MAPLE  
F/J PRIMED, RED & WHITE OAK



BASE SHOE  
1/2 x 1  
FIR



STREAMLINE  
7/16 x 1-1/2  
HEMLOCK

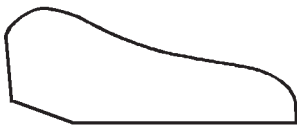

SANITARY "B"  
9/16 x 1-1/2  
HEMLOCK



SANITARY  
9/16 x 1-5/8  
MAHOGANY

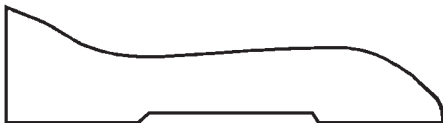

SANITARY  
5/8 x 2-1/4  
MAHOGANY



O.G. BASE  
7/16 x 2-1/4  
HEMLOCK



O.G. BASE  
5/8 x 2-3/8  
VG FIR



COLONIAL  
3/8 x 3-1/4  
HEMLOCK

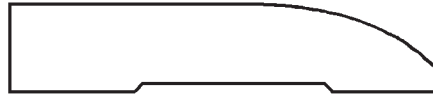

STREAMLINE  
7/16 x 2-1/4  
HEMLOCK

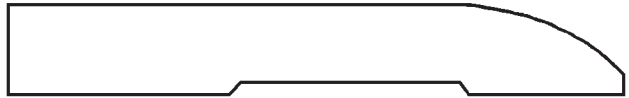

STREAMLINE  
7/16 x 3-1/4  
HEMLOCK

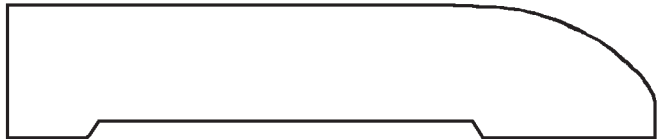

STREAMLINE  
7/16 x 3-3/8  
VG FIR



STREAMLINE  
3/8 x 2-3/4  
MAHOGANY



O.G. BASE  
3/8 x 2-1/4  
F/J PRIMED

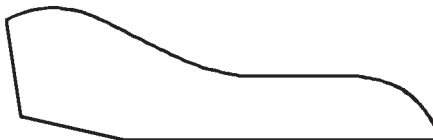

SANITARY "B"  
5/8 x 2-1/4  
HEMLOCK



O.G. BASE  
7/16 x 3-1/4  
HEMLOCK

# BASEBOARD

FIR, HEMLOCK, MDF, F/J PRIMED, & MAHOGANY



O.G. BASE  
1/2 x 3-1/4  
F/J PRIMED

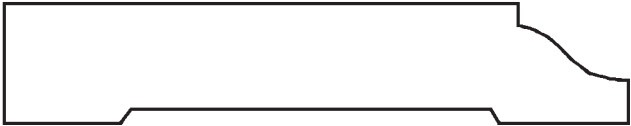

O.G. BASE  
5/8 x 3-1/4  
VG FIR

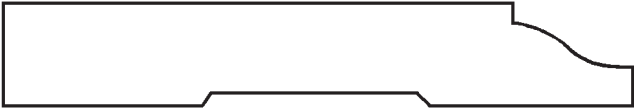

O.G. BASE  
1/2 x 3-1/4  
MDF



O.G. BASE  
1/2 x 5-1/4  
MDF



O.G. BASE  
9/16 x 5-1/4  
HEMLOCK



O.G. BASE  
9/16 x 5-1/4  
F/J PRIMED



# COVE

FIR, HEMLOCK, & F/J PRIMED

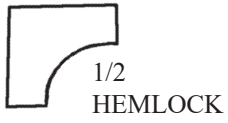

1/2  
HEMLOCK

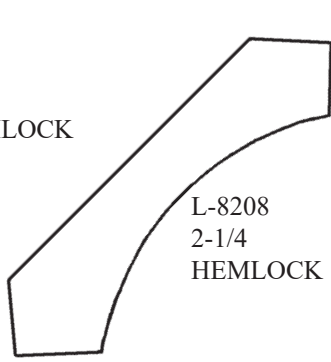

L-8208  
2-1/4  
HEMLOCK



3/4  
HEMLOCK &  
MAHOGANY

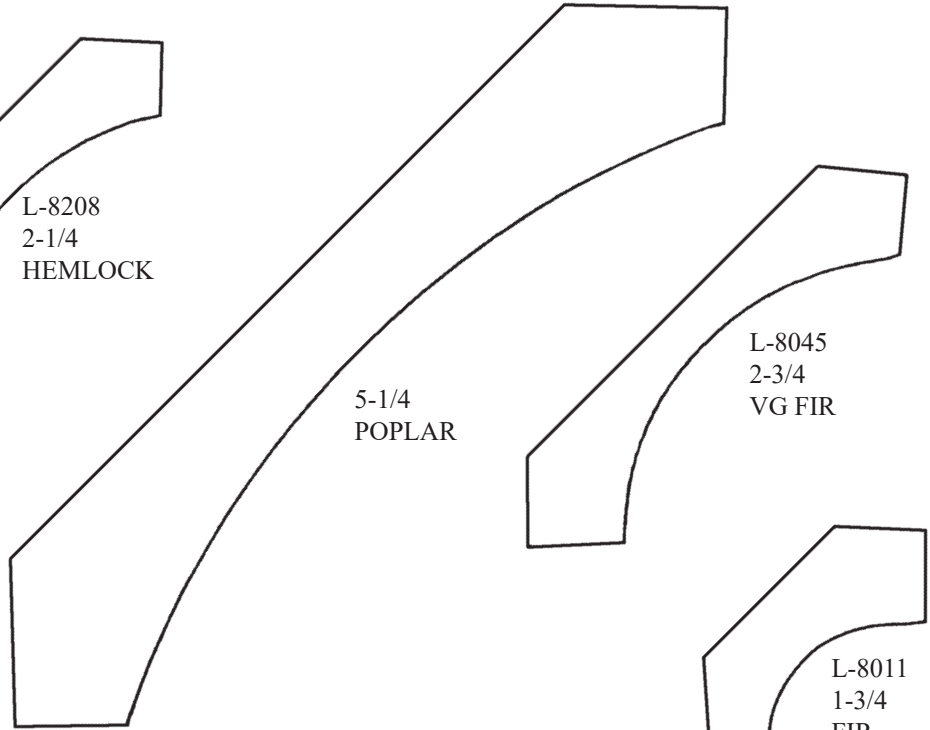

5-1/4  
POPLAR

L-8045  
2-3/4  
VG FIR

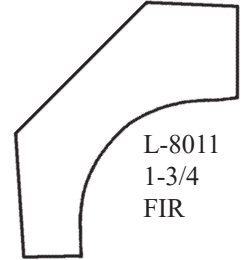

L-8011  
1-3/4  
FIR

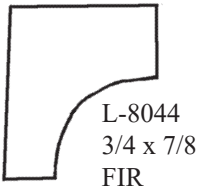

L-8044  
3/4 x 7/8  
FIR

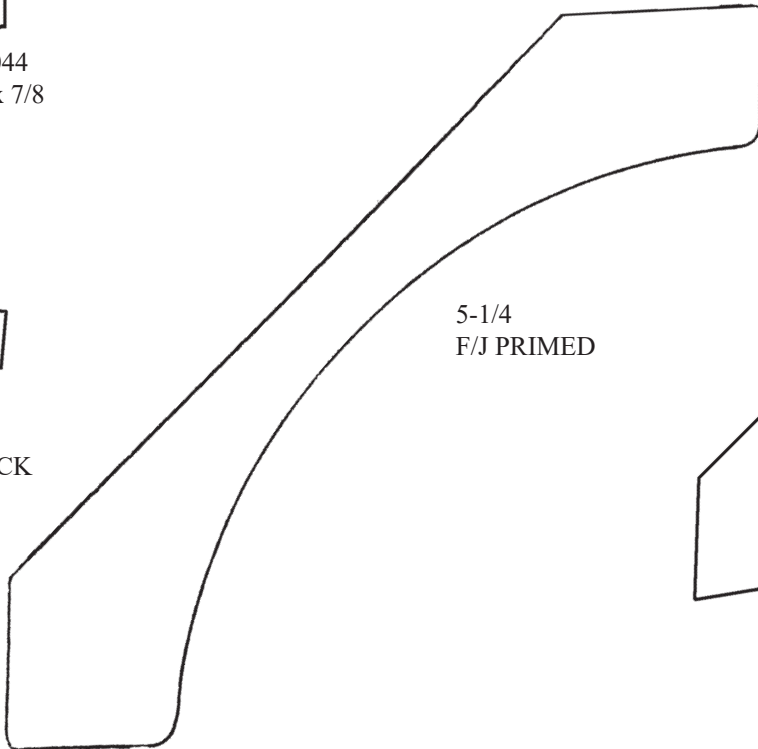

5-1/4  
F/J PRIMED

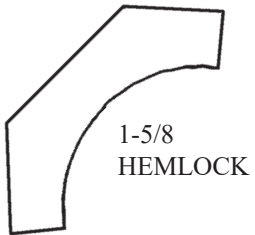

1-5/8  
HEMLOCK

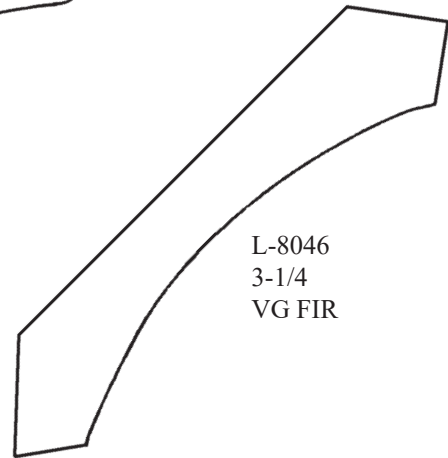

L-8046  
3-1/4  
VG FIR

# CROWN

FIR, HEMLOCK, & F/J PRIMED, & MDF

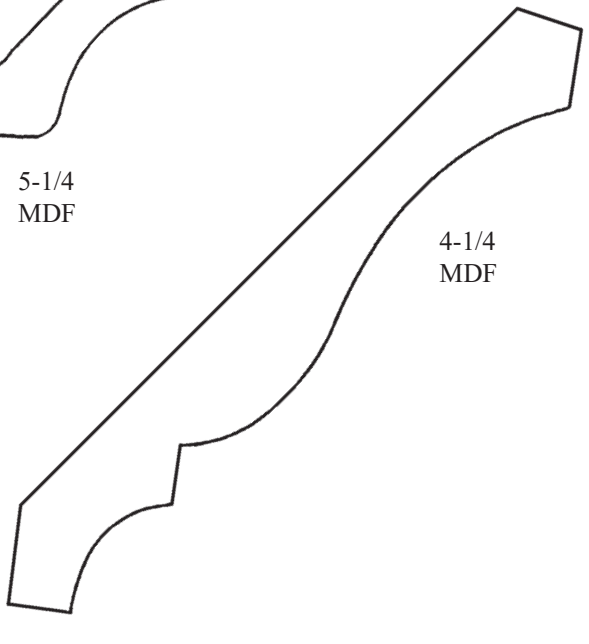
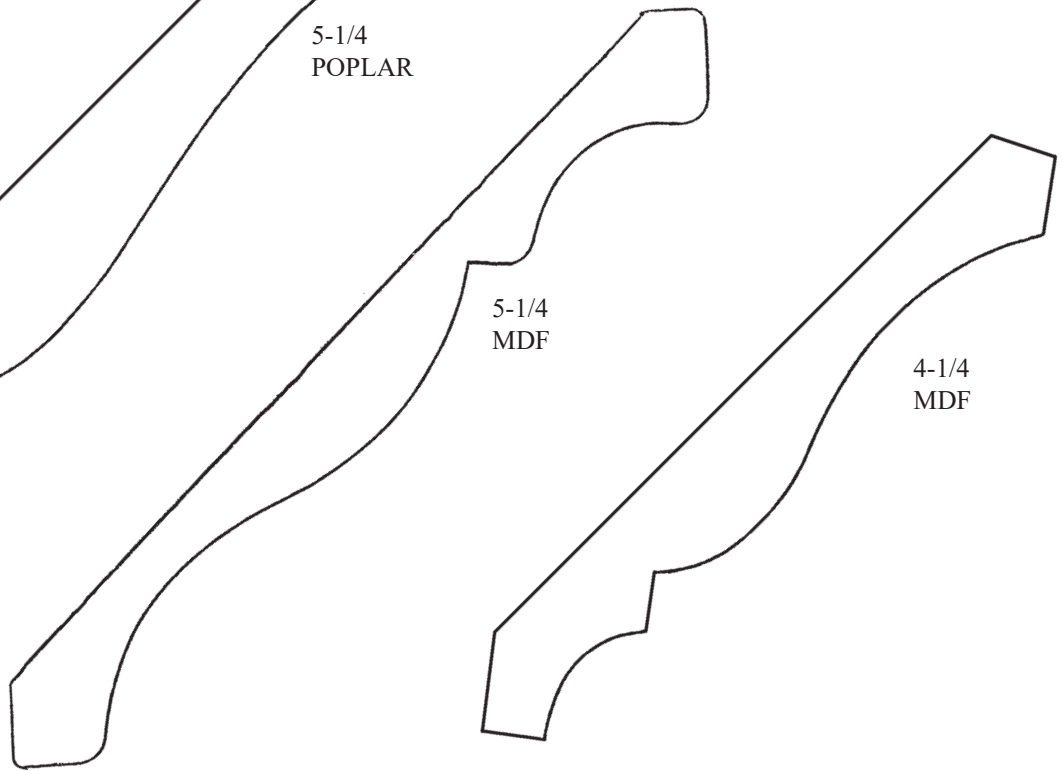
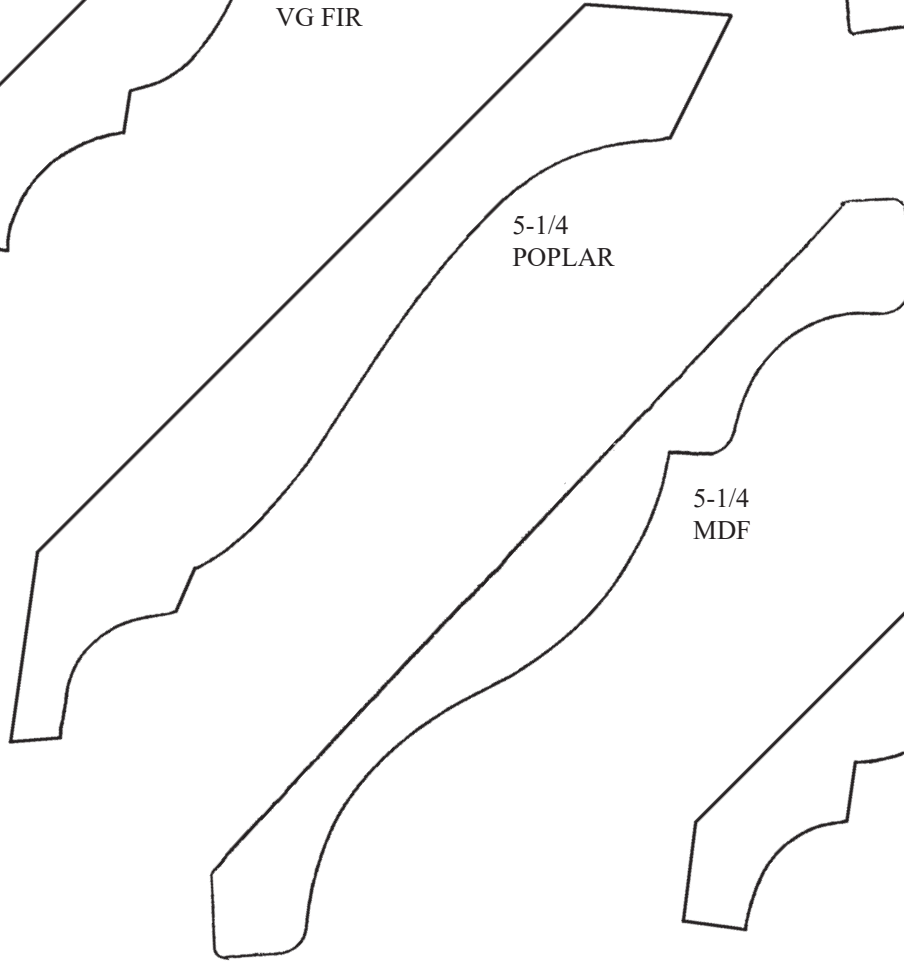
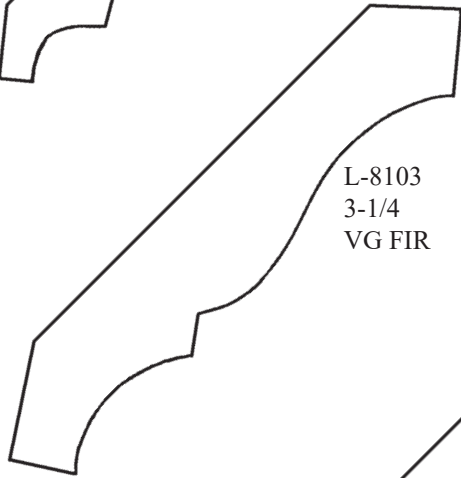
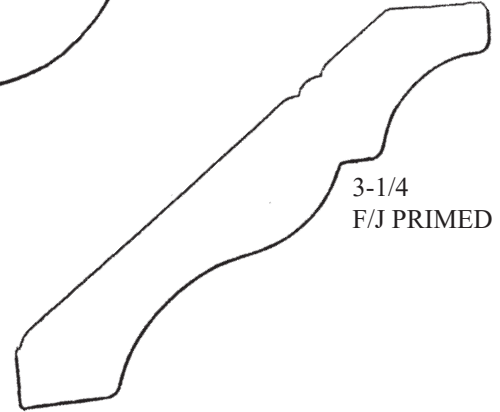
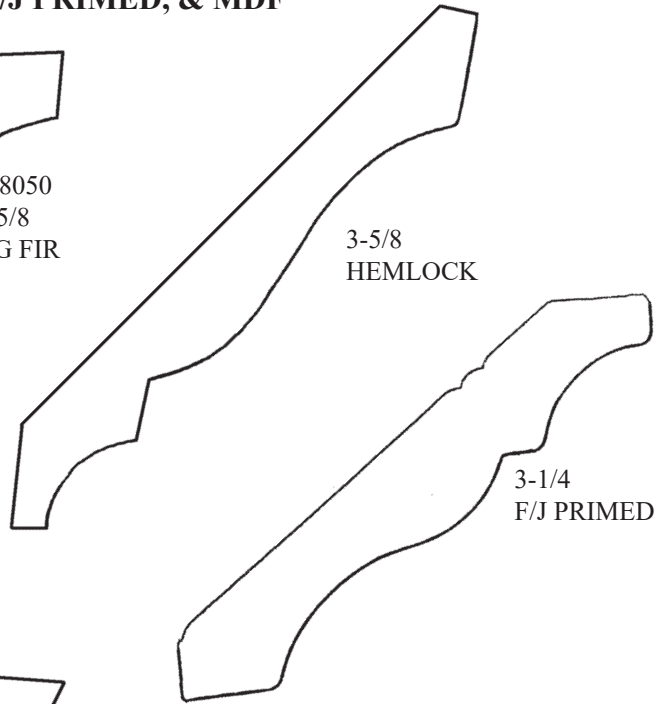
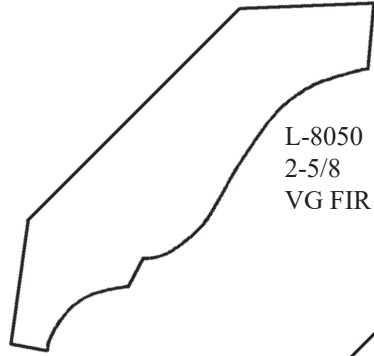

# CROWN

FIR, HEMLOCK, & F/J PRIMED, & MDF

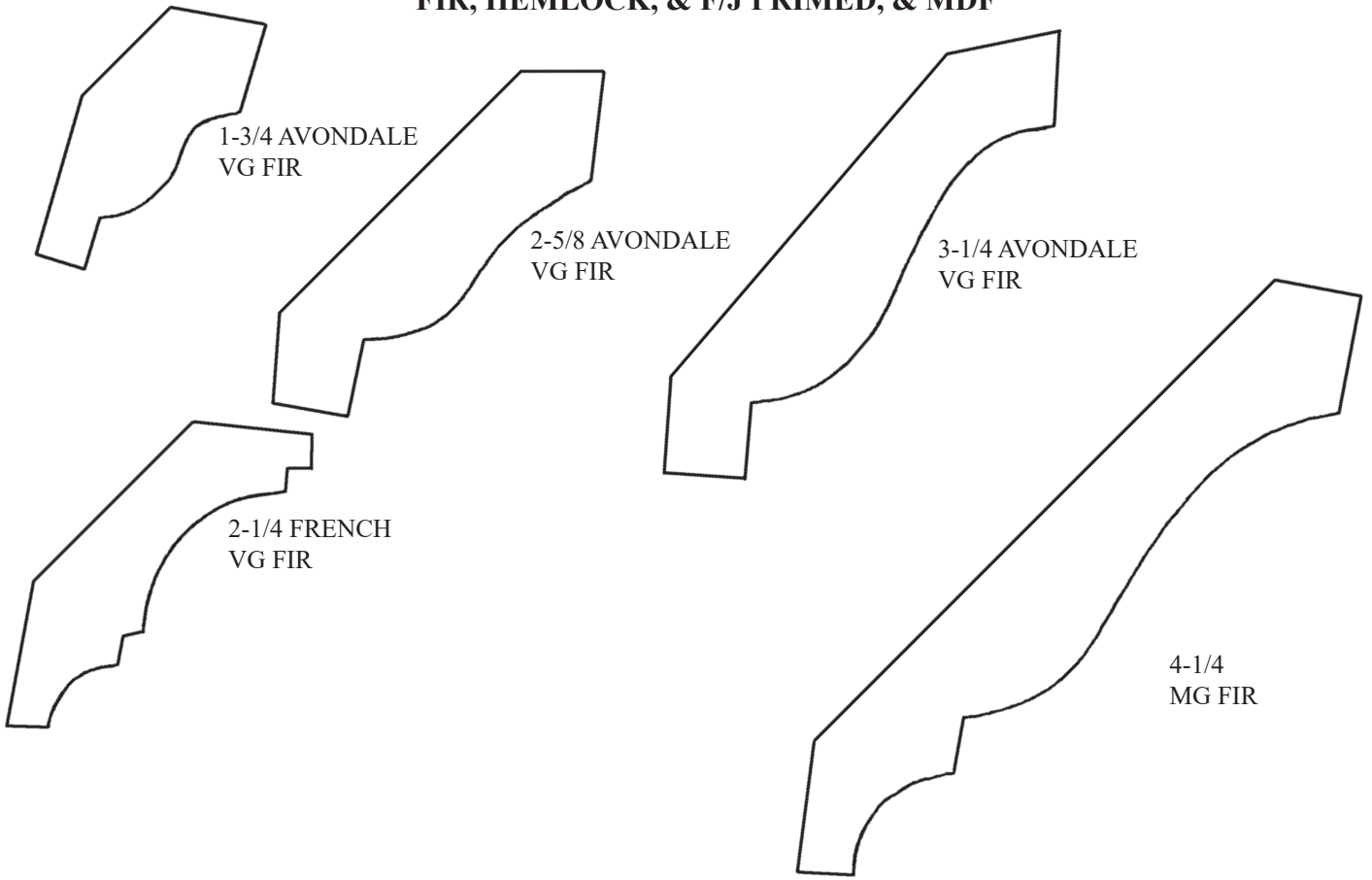

# BED MOULD

FIR & HEMLOCK

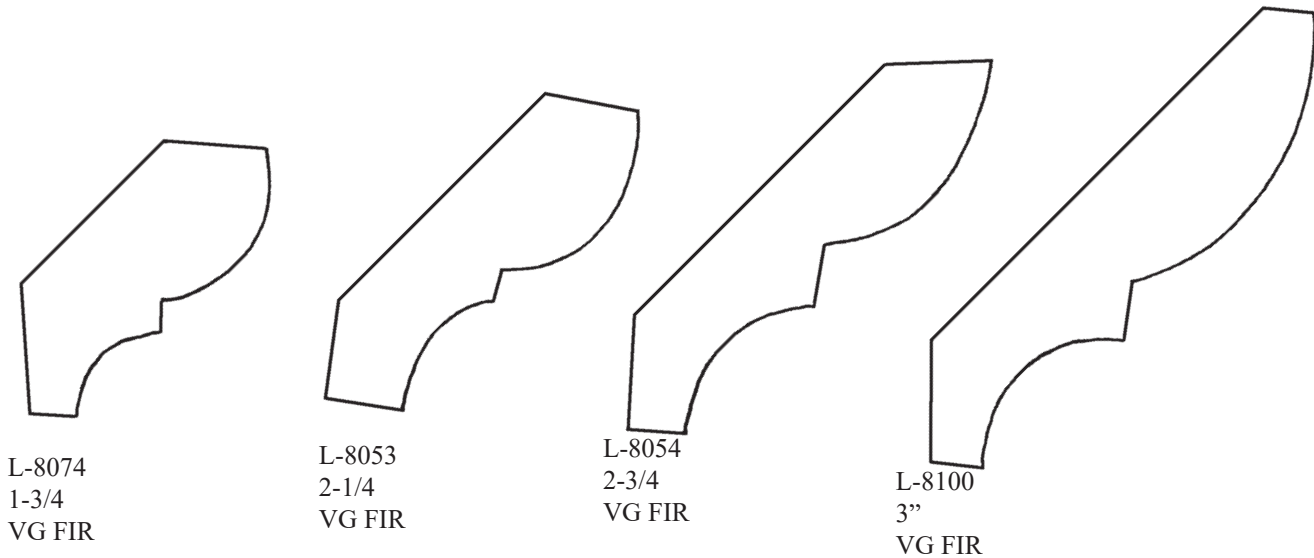

# CHAIR RAIL & BATTEN

FIR & HEMLOCK

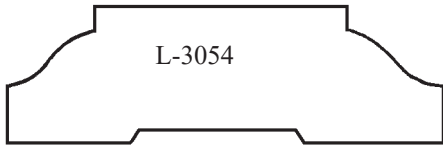

L-3054  
OG BATTEN  
9/16 x 2-1/4  
VG FIR

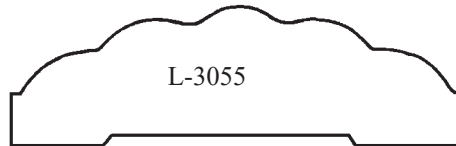

L-3055  
REEDED BATTEN  
3/4 X 2-1/2  
POPLAR



FORMERLY  
"PANEL MOULD"  
CHAIR RAIL  
9/16 x 1-5/8  
HEMLOCK

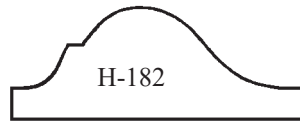

H-182  
PANEL MOULD  
9/16 x 1-9/16  
HEMLOCK

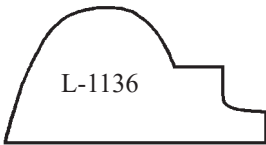

L-1136  
CHAIR RAIL  
5/8 x 1-5/16  
VG FIR

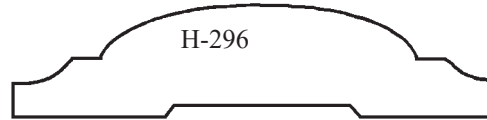

H-296  
CHAIR RAIL  
9/16 x 2-1/2  
HEMLOCK



L-1167  
CHAIR RAIL  
13/16 x 2-1/16  
VG FIR



H-297  
CHAIR RAIL  
5/8 x 3  
HEMLOCK

# PICTURE RAIL

FIR & HEMLOCK

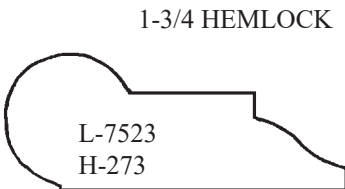

1-3/4 HEMLOCK

L-7523  
H-273



1-3/4 VG FIR

L-7051

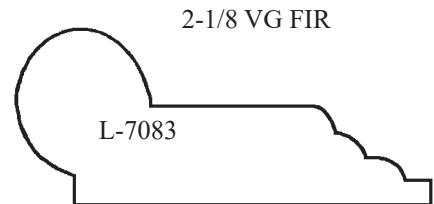

2-1/8 VG FIR

L-7083

# BRICK MOULD

FIR, HEMLOCK, & F/J PRIMED

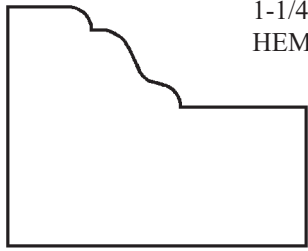

1-1/4 x 1-9/16  
HEMLOCK

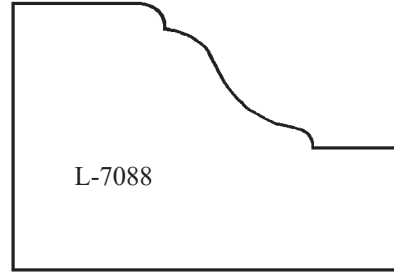

1-3/8 x 2  
VG FIR

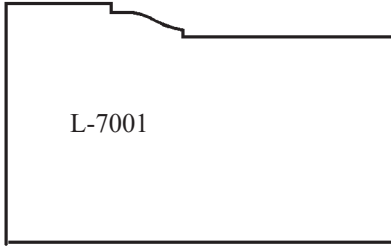

L-7001

1-1/4 x 2  
HEMLOCK &  
F/J PRIMED

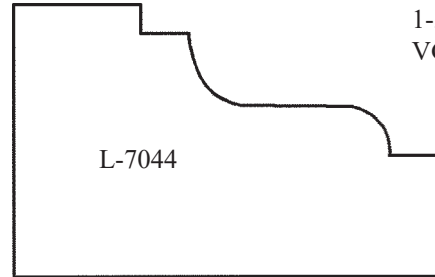

L-7044

1-3/8 x 2-1/4  
VG FIR

# CORNICE MOULD

FIR, HEMLOCK, & F/J PRIMED

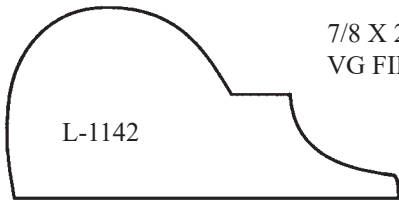

L-1142

7/8 X 2  
VG FIR

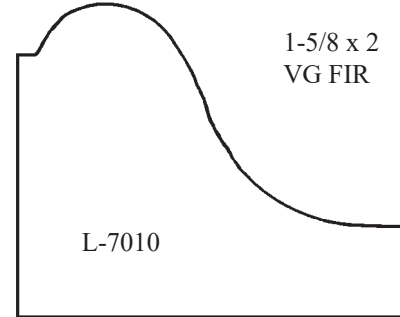

L-7010

1-5/8 x 2  
VG FIR

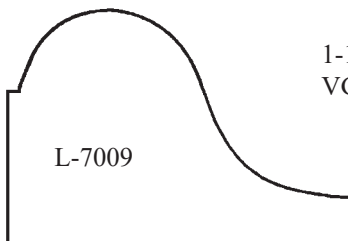

L-7009

1-1/8 x 1-3/8  
VG FIR

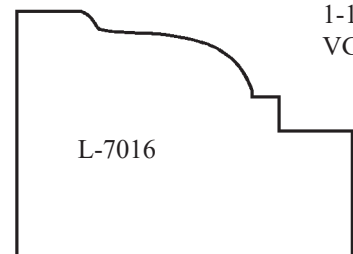

L-7016

1-1/4 x 1-3/4  
VG FIR

# CAP MOULD

FIR & F/J PRIMED

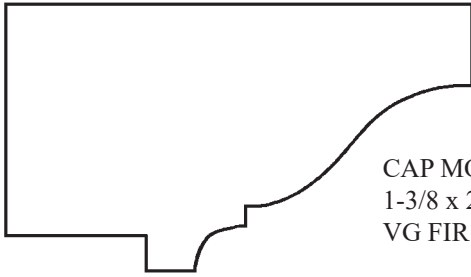

CAP MOULD #283  
1-3/8 x 2-3/8  
VG FIR & F/J PRIMED

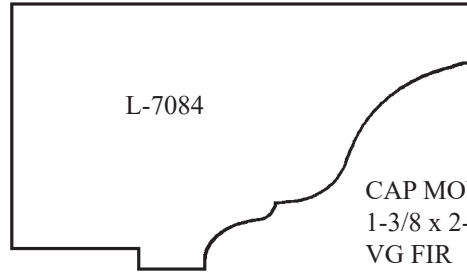

L-7084

CAP MOULD "A"  
1-3/8 x 2-3/8  
VG FIR

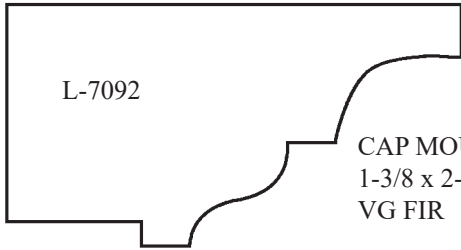

L-7092

CAP MOULD #7092  
1-3/8 x 2-3/8  
VG FIR

# BACKBAND

FIR & F/J PRIMED

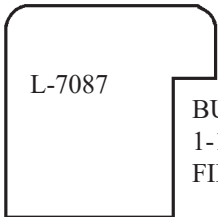

L-7087

BULLNOSED BACKBAND  
1-1/8 x 1-1/8  
FIR

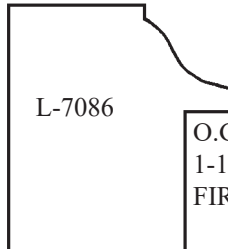

L-7086

O.G. BACKBAND  
1-1/8 x 1-5/16  
FIR

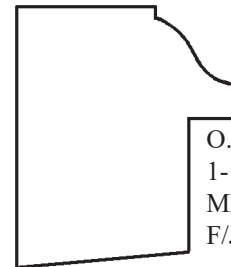

O.G. BACKBAND  
1-1/8 x 1-5/16  
MP 1022  
F/J PRIMED

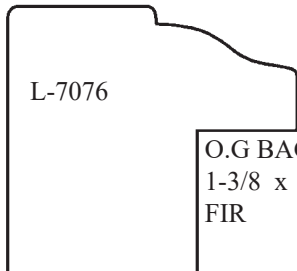

L-7076

O.G. BACKBAND  
1-3/8 x 1-7/16  
FIR

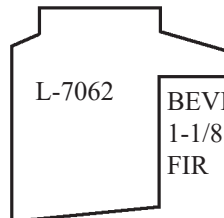

L-7062

BEVEL BACKBAND  
1-1/8 x 1-1/8  
FIR

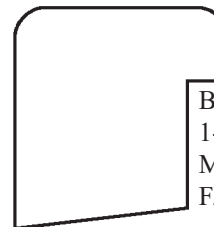

BULLNOSED BACKBAND  
1-1/16 x 1-1/16  
MP 1022  
F/J PRIMED

# RAILINGS

FIR, HEMLOCK, & F/J PRIMED

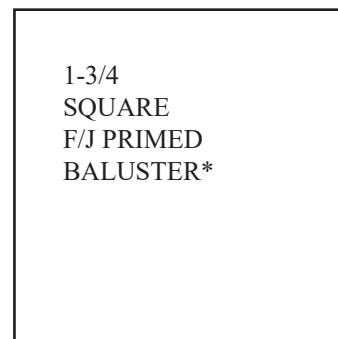
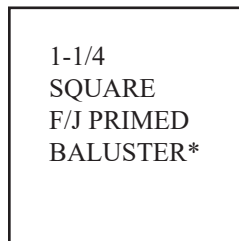
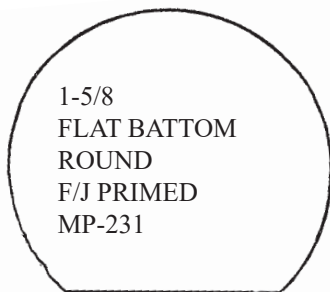
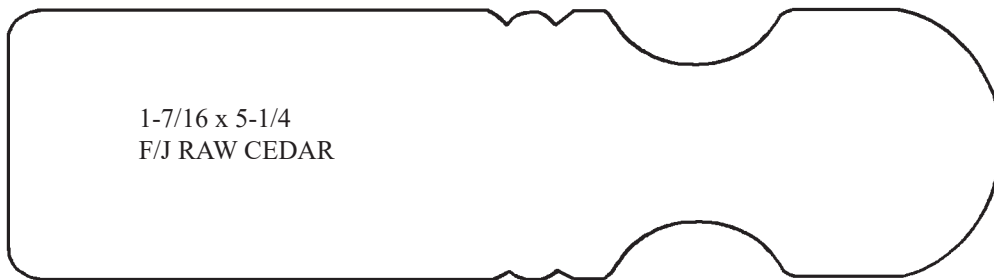
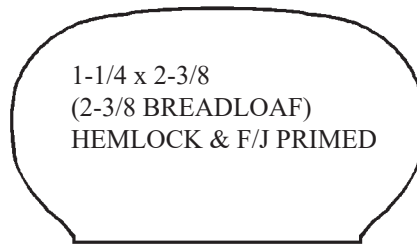
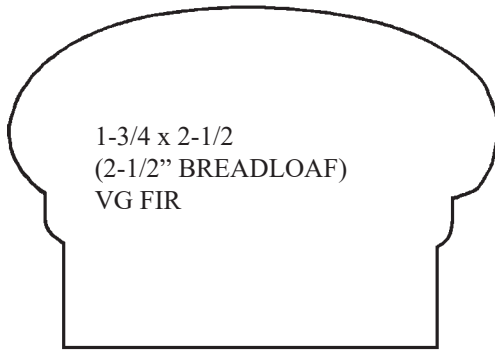
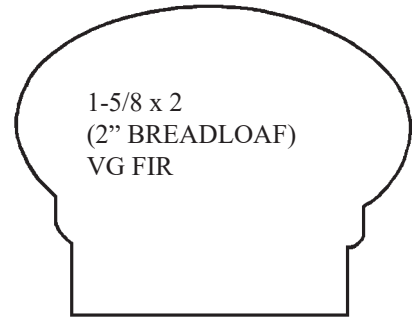
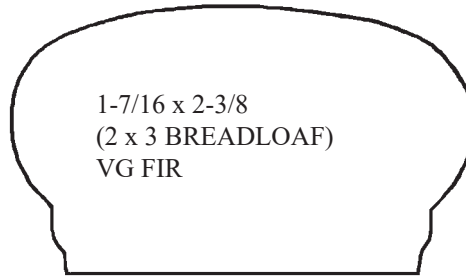
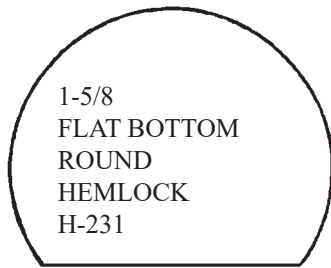

\*LJ SMITH STAIR SYSTEMS PRODUCT - PLEASE CALL FOR AVAILABILITY



# STOOL & NOSING

FIR

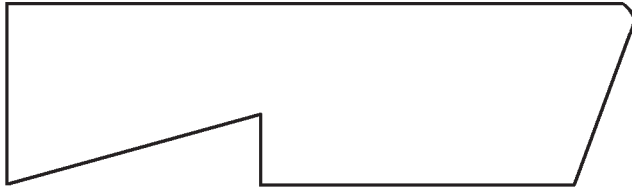

WINDOW STOOL  
1 x 3-1/4  
VG FIR

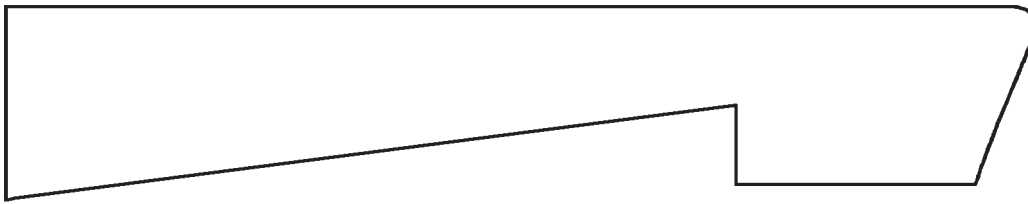

WINDOW STOOL  
1 x 5-3/8  
VG FIR



FRENCH STOOL  
1 x 5-3/8  
VG FIR

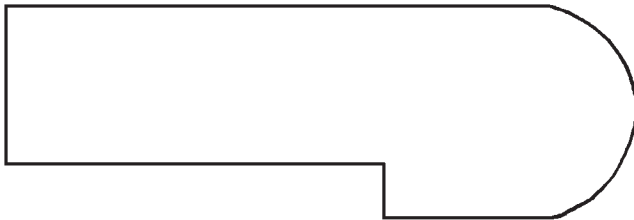

STAIR NOSING  
1 x 3-1/4  
VG FIR



STAIR NOSING  
1-1/16 x 3-1/2  
RED OAK



# FLOORING & MISC

RED OAK & FIR



STRIP FLOORING  
5/16 x 2  
RED OAK



FLOOR TRANSITION  
REDUCER  
5/16 x 1-3/8  
RED OAK

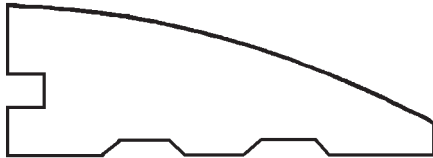

FLOOR TRANSITION  
REDUCER  
5/16 x 1-3/8  
RED OAK



BACKSPLASH  
9/16 x 3-1/2  
RED OAK

# RAKE MOULDING

FIR & HEMLOCK



H-044  
9/16 x 1-1/4  
HEMLOCK  
L-8092



L-2064  
11/16 x 2-3/8  
VG FIR

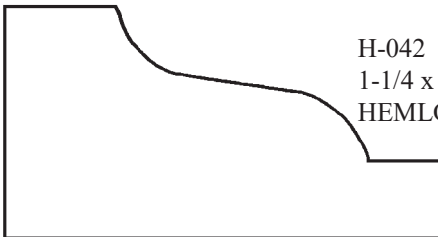

H-042  
1-1/4 x 2-1/4  
HEMLOCK



L-2068  
1 x 3-3/8  
VG FIR

# EXTERIOR APPLICATIONS

CEDAR & FIR

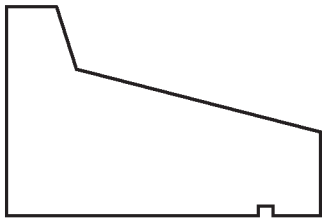

DRIP CAP  
1-1/16 x 1-5/8  
FIR

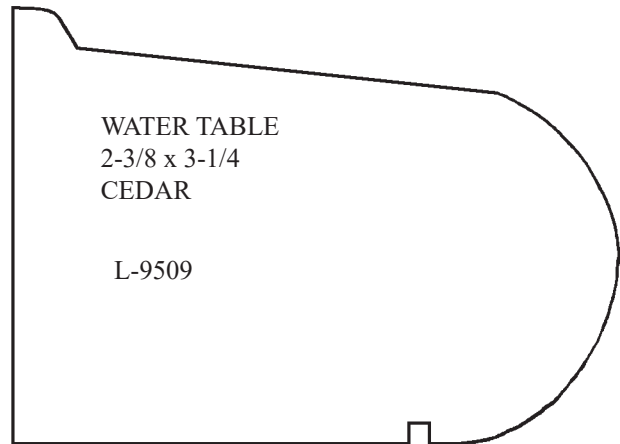

WATER TABLE  
2-3/8 x 3-1/4  
CEDAR

L-9509

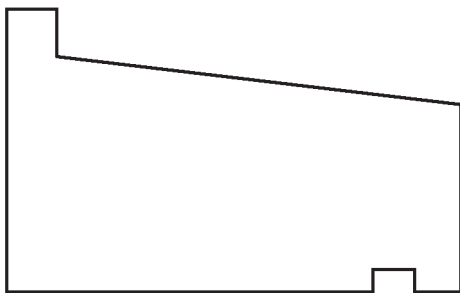

DRIP CAP  
1-7/16 x 2-3/8  
CEDAR & FIR

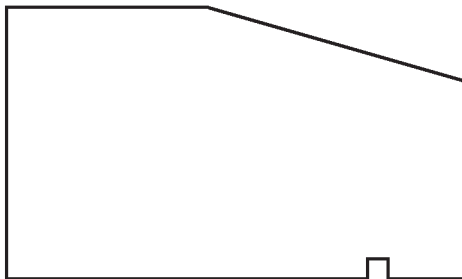

WINDOW SILL  
1-3/8 x 2-3/8  
CEDAR & F/J  
PRIMED CEDAR

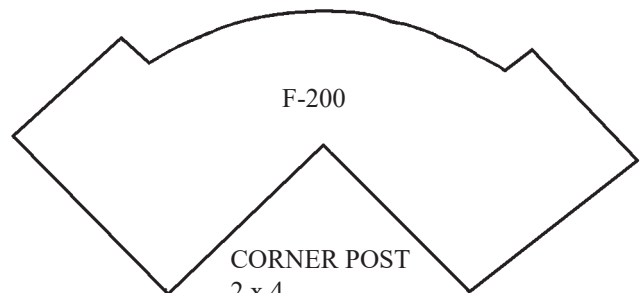

F-200

CORNER POST  
2 x 4  
FIR

# EXTERIOR APPLICATIONS

CEDAR & FIR

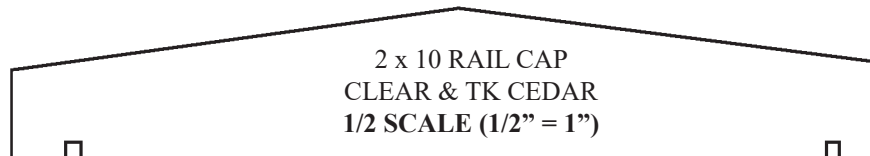
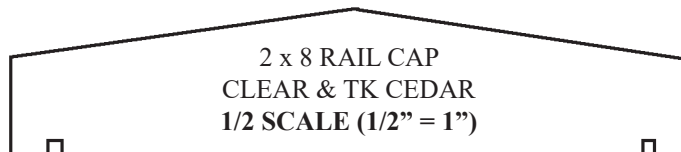
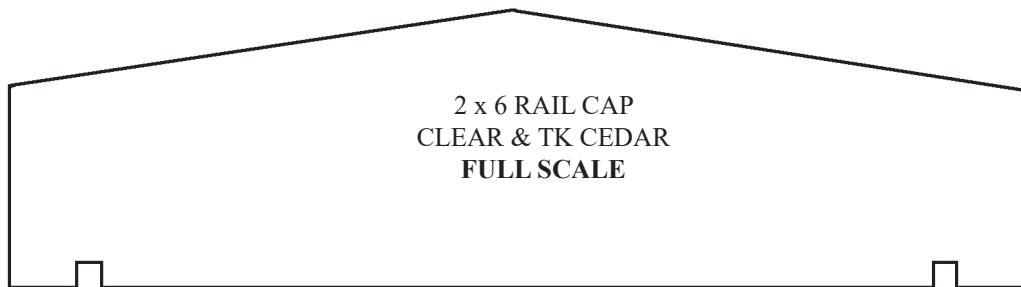
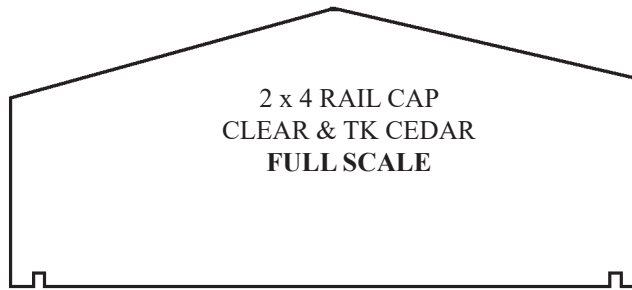

# NOTES

---