

LIMBACK LUMBER CO.

2600 NW MARKET ST, SEATTLE, WA 98107 206 782 3487 206 782 4844 FAX

WWW.LIMBACKLUMBER.COM

2017











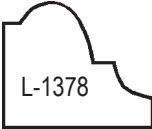



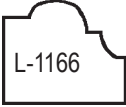
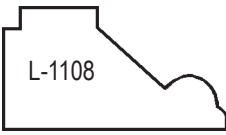







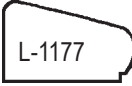

“IN STOCK” MOULDINGS

ALSO SEE OUR “SPECIAL ORDER MOLDING
CATALOUGE” ONLINE.

	PAGE
FIR AND HEMLOCK	2-11
EXTERIOR APPLICATIONS	13
MDF	14
OAK	15
MAHOGANY	16
MAPLE	16
TEAK	16

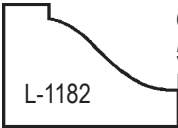
ANY MOULDING PROFILE IN THIS BOOKLET THAT HAS
AN “L-XXXX” NUMBER WITHIN ITS PROFILE, IMPLIES
THAT WE HAVE THE KNIVES IN OUR SHOP TO
MANUFACTURE THIS MOULDING PROFILE, PERHAPS
IN A DIFFERENT SPECIES OF WOOD.

TRIMS FIR & HEM

	SCREEN MOLD 3/4 HEM		BASE CAP 5/8 X 3/4 HEM		BN STOP 1/2 X 7/8 HEM
	ALICIA MOLD 5/8 FIR		BASE CAP 1/2 X 1 HEM		BN STOP 1/2 X 1-1/16 HEM
	GLASS BEAD 1/2 FIR		BASE CAP 5/8 X 1-1/16 FIR		BN STOP 1/2 X 1-3/8 HEM
	#155 GLASS BEAD 3/8 X 7/16 FIR		BASE CAP 3/4 X 1-3/4 POPLAR		BN STOP 1/2 X 1-5/8 HEM
	#046 GLASS BEAD 5/8 HEM		OG BASE SHOE 1/2 X 1-3/8 FIR		BN STOP 1/2 X 2-1/4 HEM
	BEVEL STOP 7/16 X 9/16 FIR #151		LATTICE 1/4 X 1-1/6 HEM		LATTICE 1/4 X 1-5/16 HEM
	WINDOW STOP 3/4 FIR L-1177		BASE CAP 11/16 X 1-3/8 FIR L-1137		LATTICE 1/4 X 1-5/8 HEM
	GLASS STOP F-159 3/8 X 11/16		OG BASE CAP 5/8 X 1-5/8 FIR L-1202		LATTICE 1/4 X 2-1/8 HEM
	OG STOP 5/8 X 7/8 FIR L-1182		BEVEL BASE CAP 5/8 X 1-5/8 FIR L-1176		FILLET 7/16 x 1-1/4 FIR AND F/J PRIMED L-1175
	OG STOP 7/16 X 1-3/8 HEM				

TRIMS FIR & HEM

PANEL CAPS HEM WAINSCOT CAPS HEM OUTSIDE CORNERS HEM

1-3/8

1-7/8

1-1/8

1/4"

1/2" I.S.

3/4 CANT
KNOTTY PINE

ALSO IN STOCK
3-1/2 CANT
UTILITY FIR

1-1/2 CANT
KNOTTY PINE

3/4" I.S.

1-1/16 I.S.

QUARTER ROUNDS HEM HALF ROUNDS HEM ROUNDS HEM

1/4

3/8

L-1141 1/2

3/4

L-1242 1/2

L-1179 3/4

HEM &
PRIMED

L-1236 3/4

1-1/16

FIR ONLY
L-1180 1"

1"

L-1115 1-1/2

1"

SQUARES HEM

11/16
SQUARE

1/2 X 3/4
PARTING
BEAD

2"
FIR ONLY

1-5/16

CLOSET ROD

1-1/16
SQUARE

1-9/16

HANDRAIL

CASINGS FIR & HEM

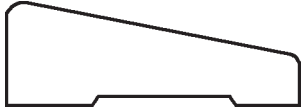

WEDGE
1/2 X 1-1/2
HEM

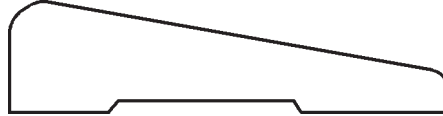

WEDGE
1/2 X 2-1/4
HEM



BULL NOSED
1/2 X 1-1/2
HEM



BULL NOSED
1/2 X 2-1/4
HEM & PRE-PRIMED

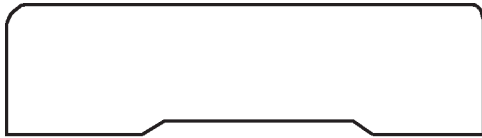

BULL NOSED
11/16 X 2-1/2
V.G. HEM AND V.G. FIR

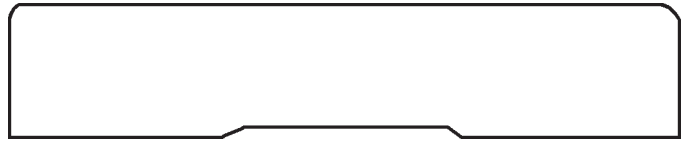

BULL NOSED
11/16 X 3-1/2
V.G. HEM AND V.G. FIR



STREAMLINE
1/2 X 1-5/8
HEM

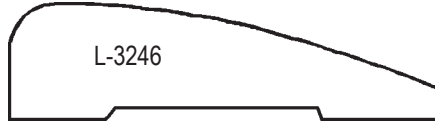

L-3246

STREAMLINE
1/2 X 2-1/4
HEM

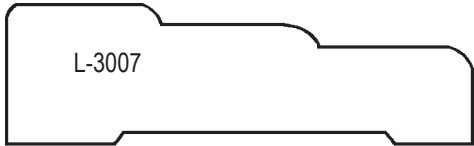

L-3007

MOLDED
5/8 X 2-3/8
V.G. FIR



MOLDED
9/16 X 2-1/4
HEM

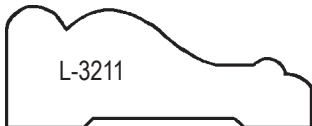

L-3211

BEADED
1/2 X 1-1/2
HEM

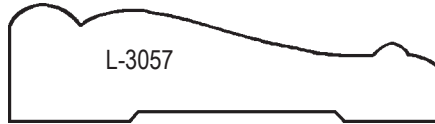

L-3057

BEADED
1/2 X 2-1/4
HEM

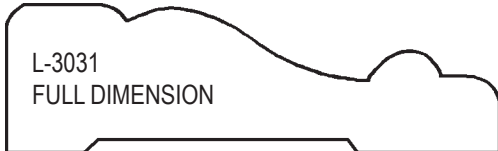

L-3031
FULL DIMENSION

BEADED
3/4 X 2-1/2
V.G. FIR &
POPLAR



BEADED
9/16 X 2-1/2
HEM

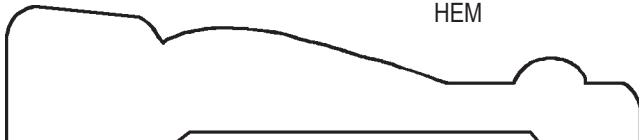

BEADED
5/8 X 3-1/4
HEM



L-4088

CALYPSO
3/4 X 2-1/2
POPLAR

CASINGS FIR & HEM

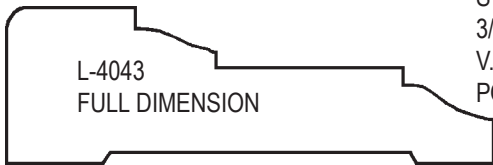

STEP
3/4 X 2-1/2
V.G. FIR &
POPLAR

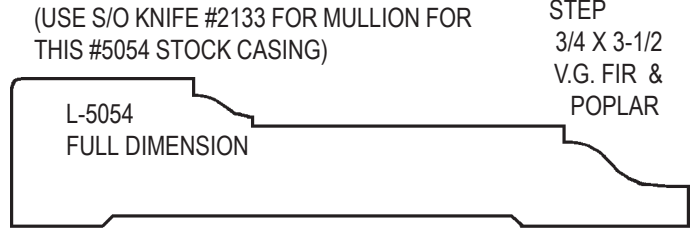

(USE S/O KNIFE #2133 FOR MULLION FOR
THIS #5054 STOCK CASING)

STEP
3/4 X 3-1/2
V.G. FIR &
POPLAR

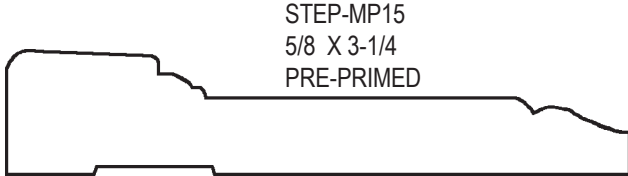

STEP
5/8 X 3-3/8
HEM

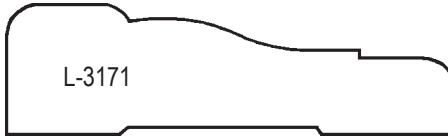

COLONIAL
11/16 X 2-1/4
HEM

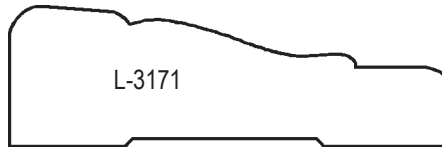

COLONIAL
11/16 X 2-1/4
V.G. FIR

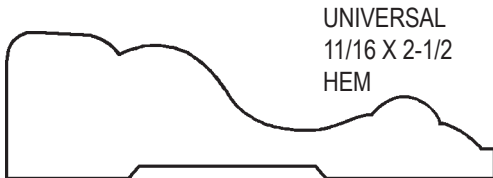

BASES FIR & HEM

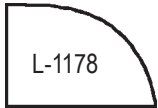

BASE SHOE
1/2 X 3/4
HEM, FIR & PRE-PRIMED
IN STOCK



STREAMLINE BASE
7/16 X 2-1/4
HEM

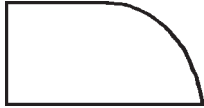

BASE SHOE
1/2 X 1"
FIR



STREAMLINE BASE
7/16 X 3-1/4
HEM



STREAMLINE BASE
7/16 X 1-1/2
HEM

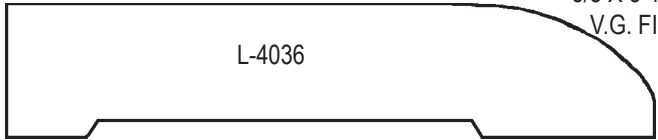

STREAMLINE BASE
5/8 X 3-1/4
V.G. FIR

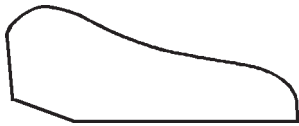

SANITARY BASE
STYLE "B"
9/16 X 1-1/2
HEM



SANITARY BASE
STYLE "A"
7/8 X 2-1/4
HEM



COLONIAL BASE
3/8 X 3-1/4
HEM

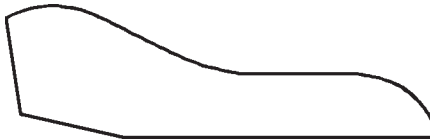

SANITARY BASE
STYLE "B"
11/16 X 2-1/4
HEM



O.G. BASE
7/16 X 2-1/4
HEM



O.G. BASE
7/16 X 3-1/4
HEM



O.G. BASE
5/8 X 2-3/8
V.G. FIR



O.G. BASE
5/8 X 3-1/4
V.G. FIR



O.G. BASE
1/2 X 3-1/4
PRE-PRIMED

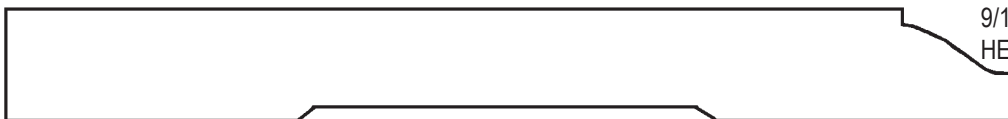

O.G. BASE
9/16 X 5-1/4
HEM

COVES FIR & HEM

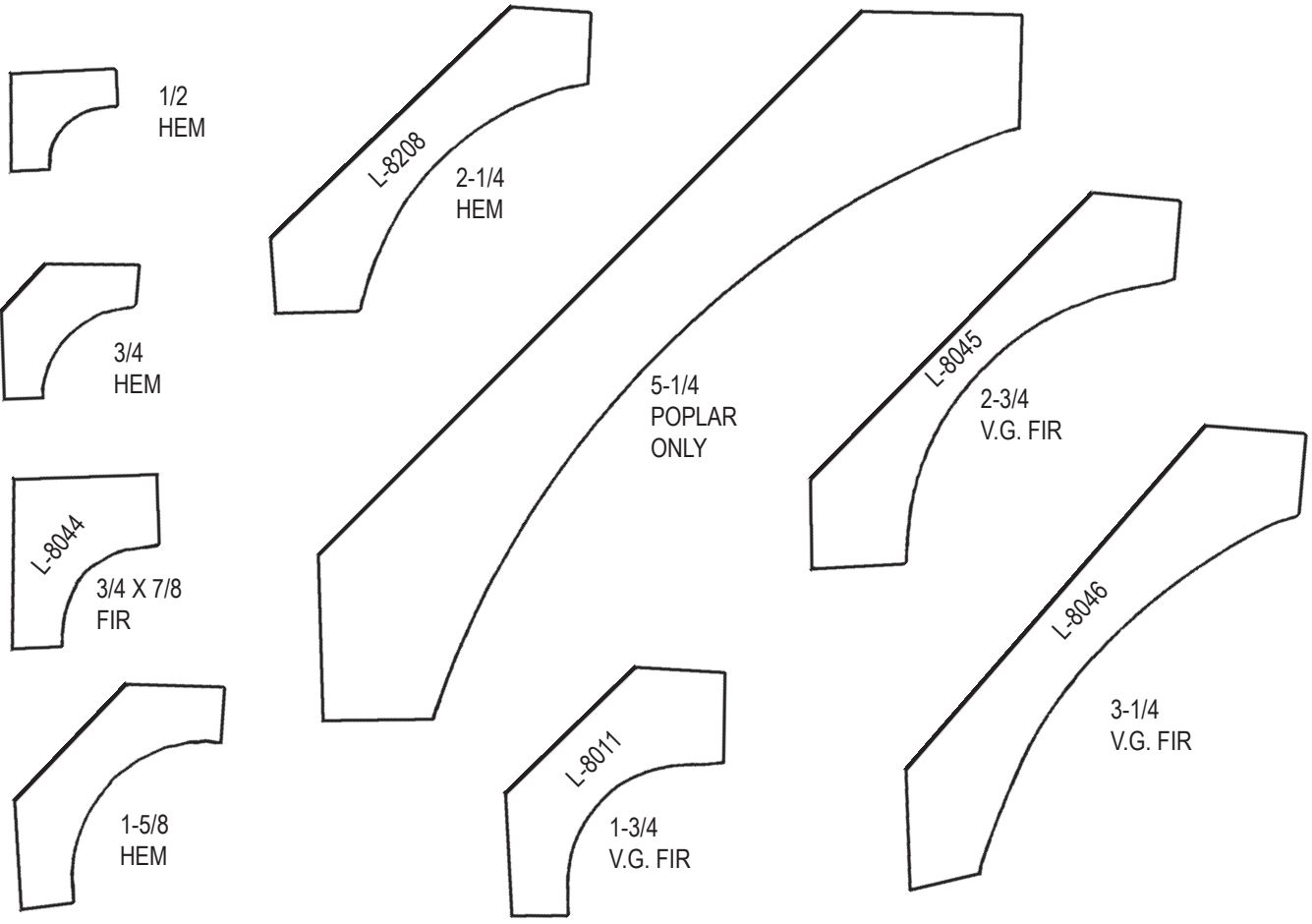

BED MOULDING FIR

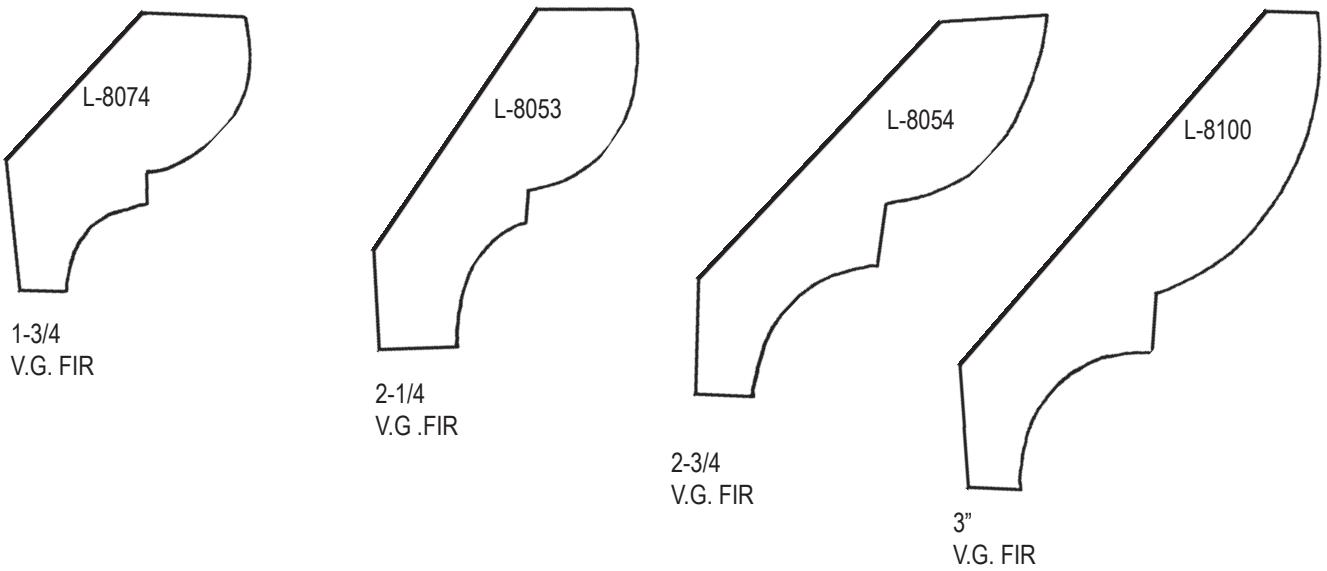

CROWNS FIR & HEM

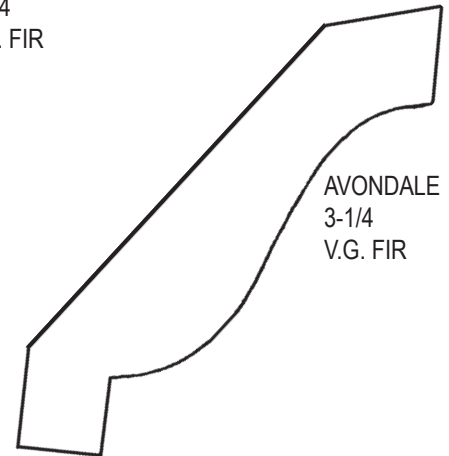
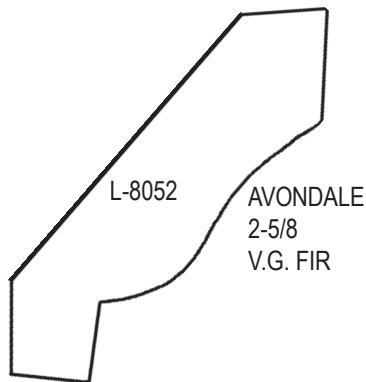
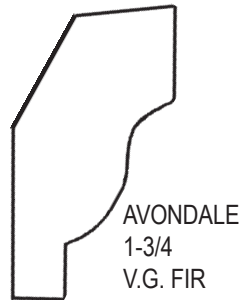
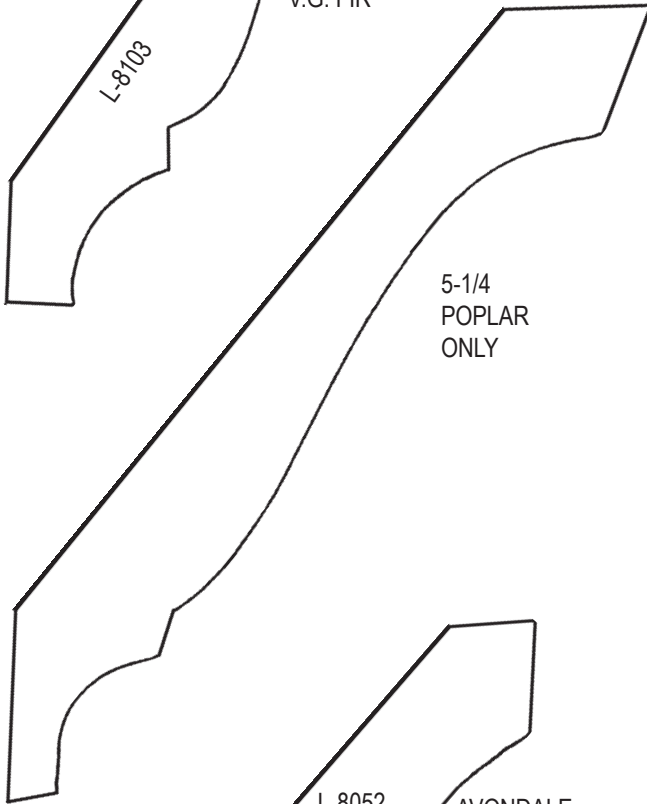
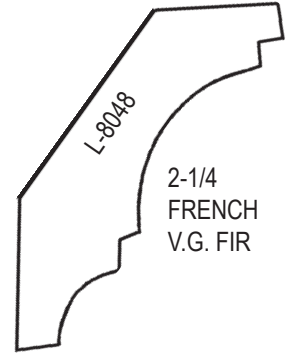
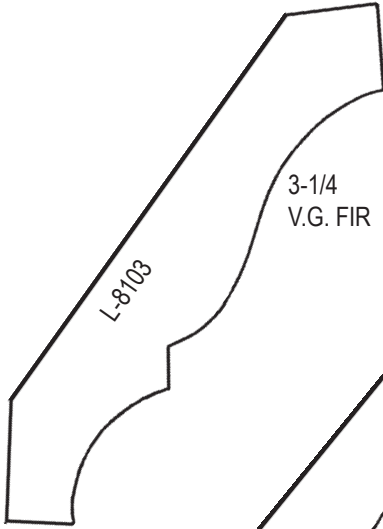
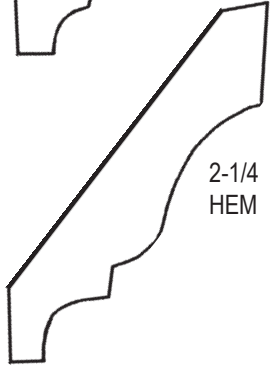
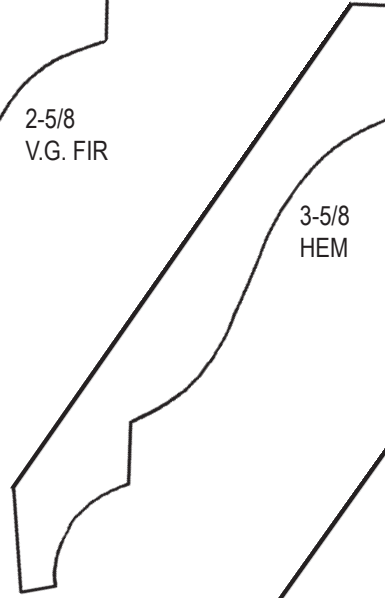
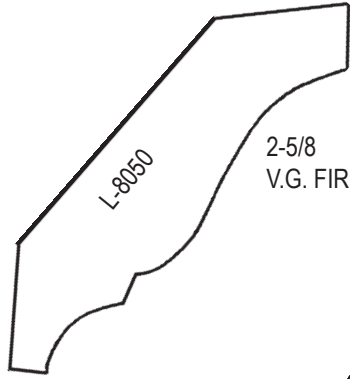

RAKE MOULDING **FIR & HEM**

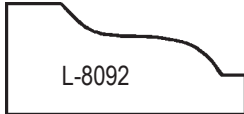

H-044
9/16 X 1-1/4
HEM

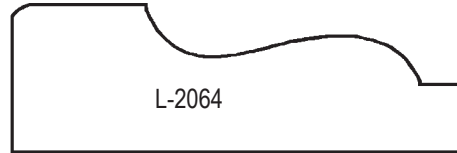

11/16 X 2-3/8
V.G. FIR

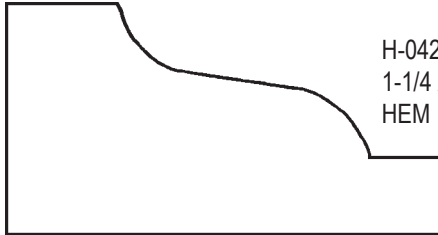

H-042
1-1/4 X 2-1/4
HEM

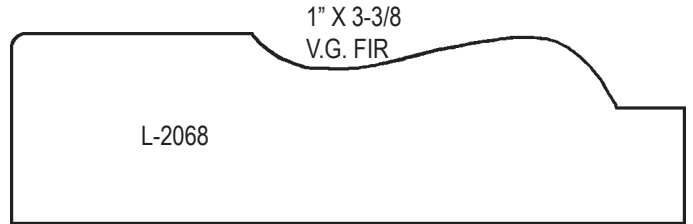

1" X 3-3/8
V.G. FIR

PICTURE, BATTEN, CHAIR RAIL **FIR&HEM**

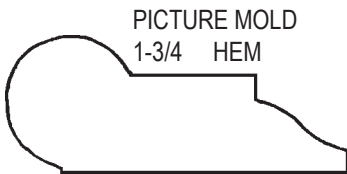

PICTURE MOLD
1-3/4 HEM

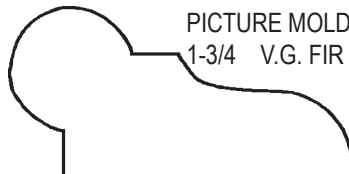

PICTURE MOLD
1-3/4 V.G. FIR

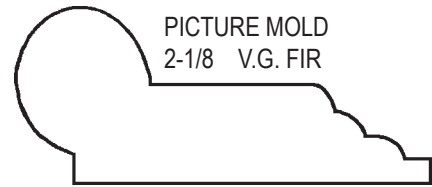

PICTURE MOLD
2-1/8 V.G. FIR

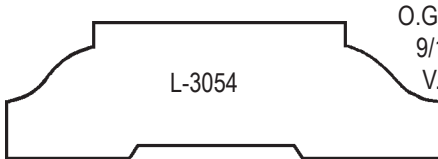

O.G. BATTEN
9/16 X 2-1/4
V.G. FIR

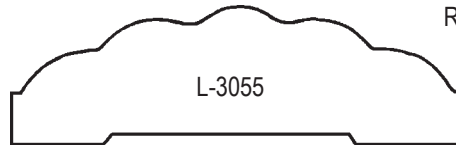

REEDED BATTEN
5/8 X 2-3/8
V.G. FIR



PANEL MOLD
9/16 X 1-5/8
HEM



PANEL MOLD
9/16 X 1-9/16
HEM

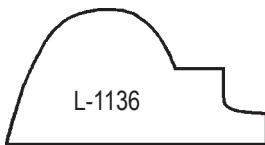

CHAIR RAIL
5/8 X 1-5/16
V.G. FIR



CHAIR RAIL
9/16 X 2-1/2
HEM



CHAIR RAIL
13/16 X 2-1/16
V.G. FIR



CHAIR RAIL
5/8 X 3"
HEM

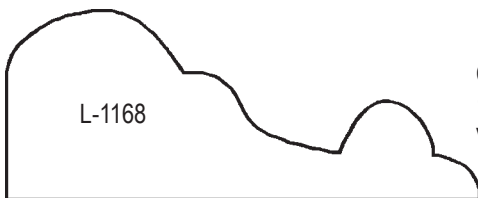

CHAIR RAIL
1" X 2-1/2
V.G. FIR

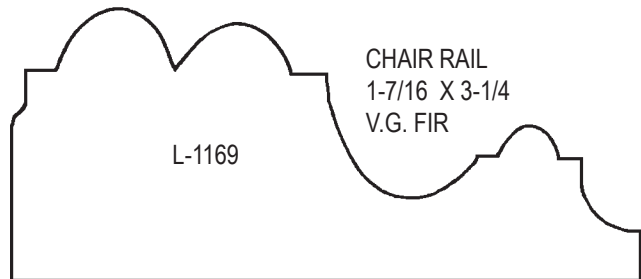

CHAIR RAIL
1-7/16 X 3-1/4
V.G. FIR

BRICK & CORNICE MOLD FIR & HEM

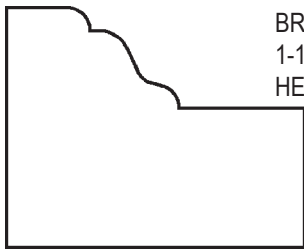

BRICK MOLD
1-1/4 X 1-9/16
HEM



BRICK MOLD
1-3/8 X 2
FIR

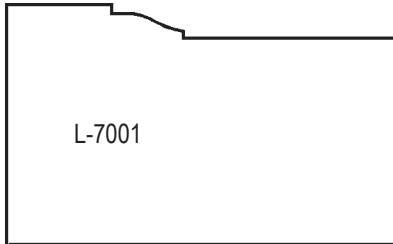

L-7001

BRICK MOLD
1-1/4 X 2
SOLID HEM &
F/J PRIMED



L-7044

BRICK MOLD
1-3/8 X 2-1/4
VG FIR

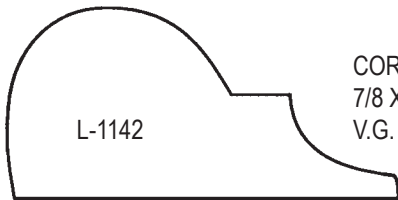

L-1142

CORNICE MOLD
7/8 X 2"
V.G. FIR

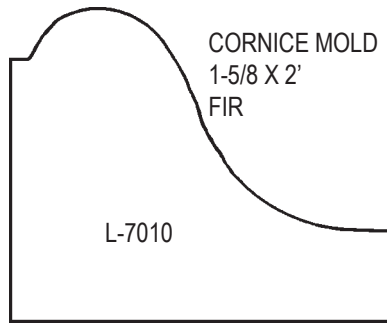

L-7010

CORNICE MOLD
1-5/8 X 2'
FIR

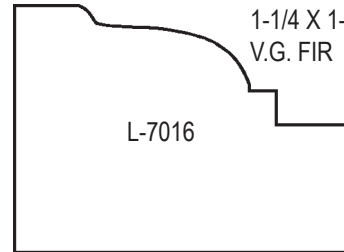

L-7016

CORNICE MOLD
1-1/4 X 1-3/4
V.G. FIR

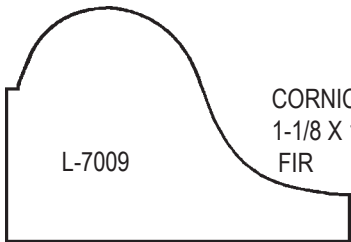

L-7009

CORNICE MOLD
1-1/8 X 1-3/4
FIR

CAP MOLD FIR

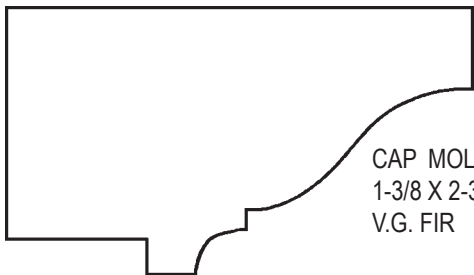

CAP MOLD "283"
1-3/8 X 2-3/8
V.G. FIR

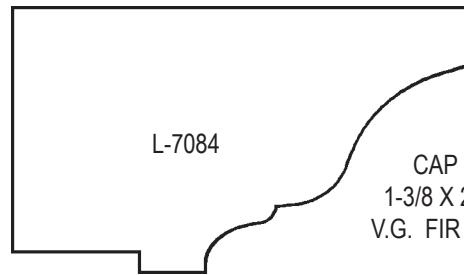

L-7084

CAP MOLD "A"
1-3/8 X 2-3/8
V.G. FIR

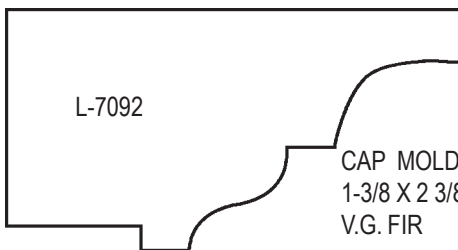

L-7092

CAP MOLD "7092"
1-3/8 X 2 3/8
V.G. FIR

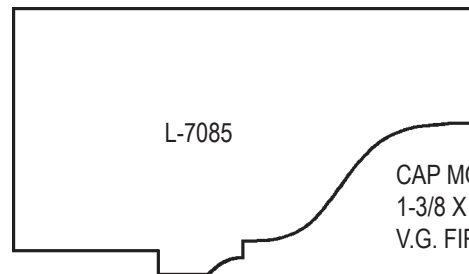

L-7085

CAP MOLD "B"
1-3/8 X 2-3/8
V.G. FIR

RAILINGS **FIR & HEM**

PLOWING SERVICE FOR BALLISTERS/SPINDLES AVAILABALE

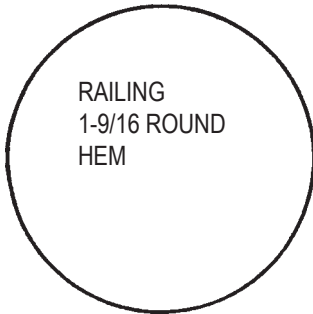
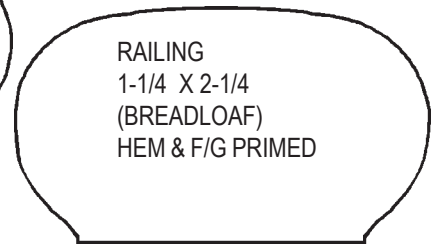
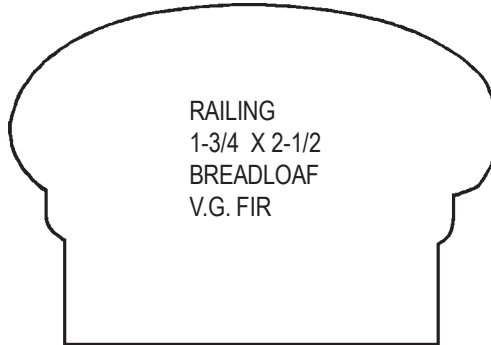
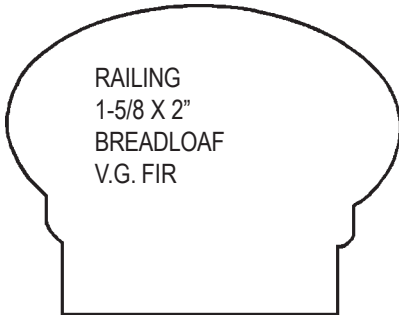
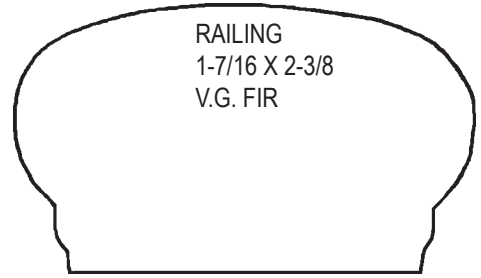
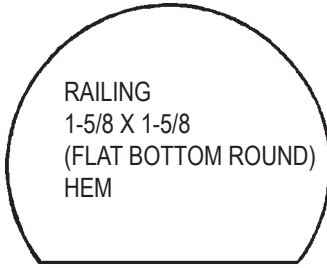
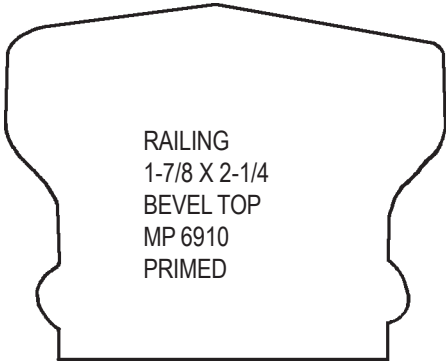

BACKBAND MOLD **FIR**

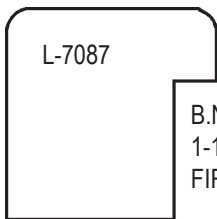

B.N. BACKBAND
1-1/8 X 1-1/8
FIR

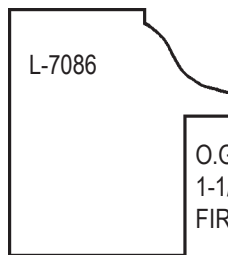

O.G. BACKBAND
1-1/8 X 1-5/16
FIR



O.G. BACKBAND
1-1/8 X 1-5/16
MP 1022
PRIMED

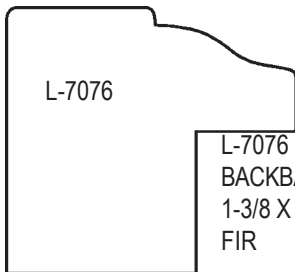

L-7076
BACKBAND
1-3/8 X 1-7/16
FIR

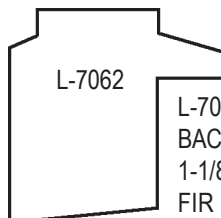

L-7062
BACKBAND
1-1/8 X 1-1/8
FIR

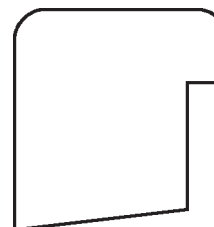

B.N. BACKBAND
1-1/16 X 1-1/16
MP 1021
PRIMED

STOOL & NOSING **FIR**

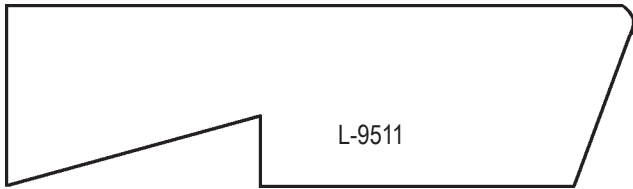

WINDOW STOOL
1" X 3-1/4
V.G. FIR

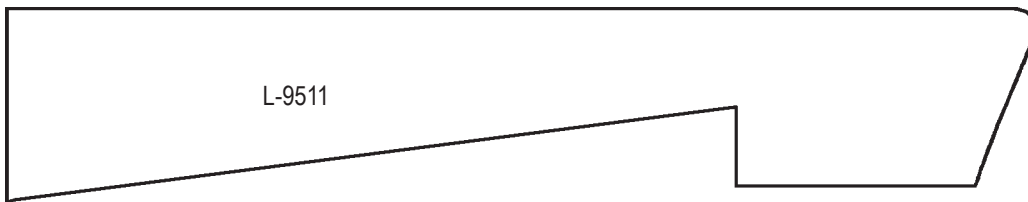

WINDOW STOOL
1" X 5-3/8
V.G. FIR



FRENCH STOOL
1" X 5-3/8
V.G. FIR

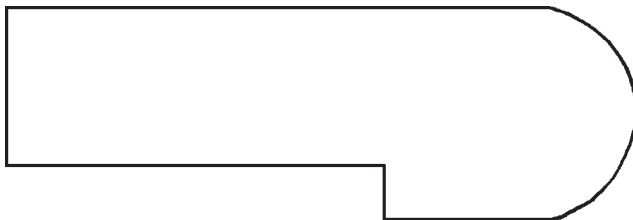

STAIR NOSING
1" X 3-1/4
V.G. FIR

EXTERIOR APPLICATIONS

CEDAR OR FIR

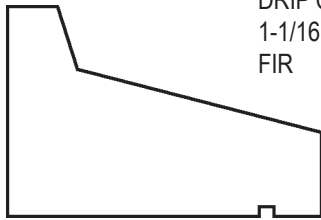

DRIP CAP
1-1/16 X 1-5/8
FIR

WATER TABLE
2-3/8 X 3-1/4
CEDAR

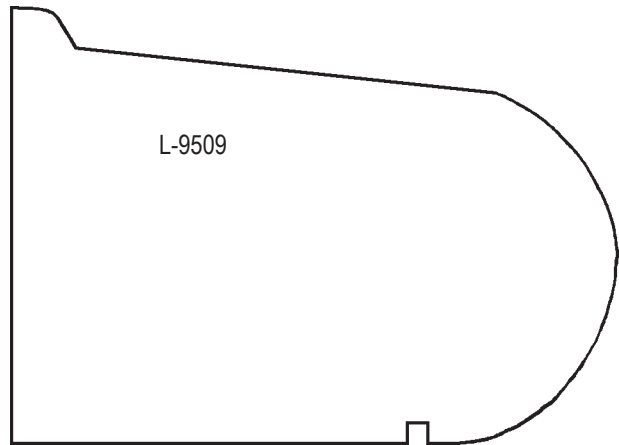

L-9509

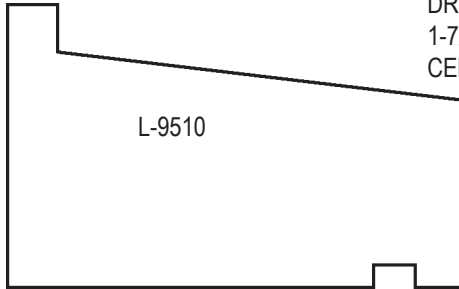

DRIP CAP
1-7/16 X 2-3/8
CEDAR

L-9510

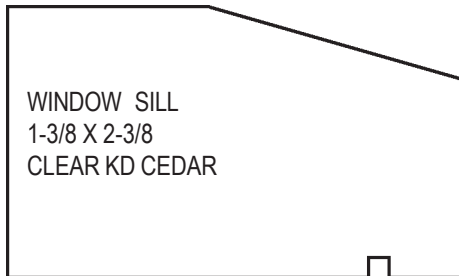

WINDOW SILL
1-3/8 X 2-3/8
CLEAR KD CEDAR

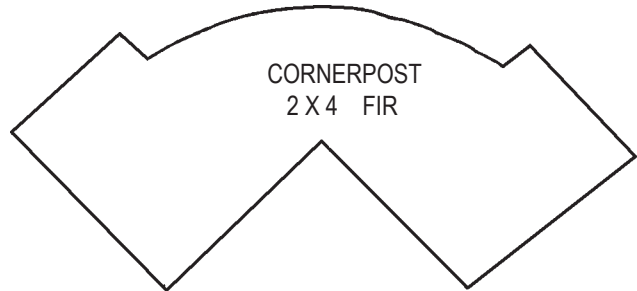

CORNERPOST
2 X 4 FIR

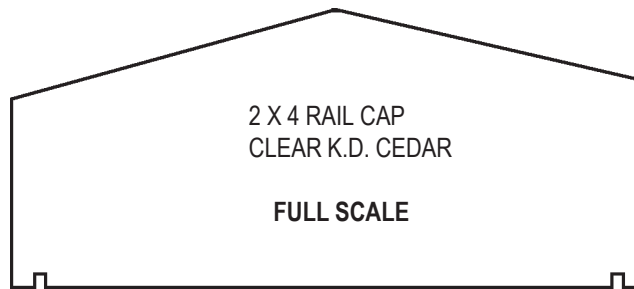

2 X 4 RAIL CAP
CLEAR K.D. CEDAR

FULL SCALE

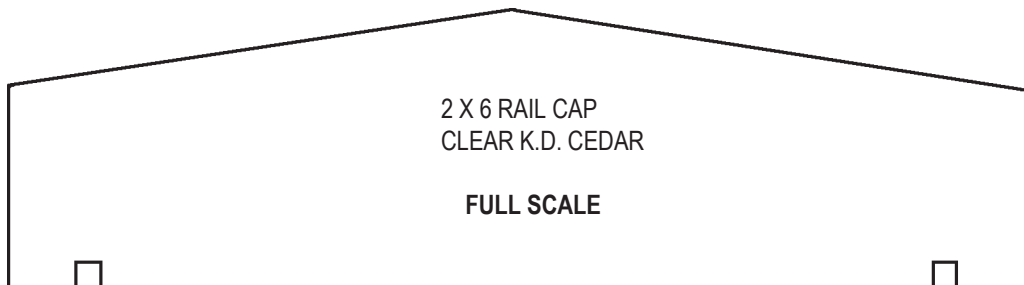

2 X 6 RAIL CAP
CLEAR K.D. CEDAR

FULL SCALE

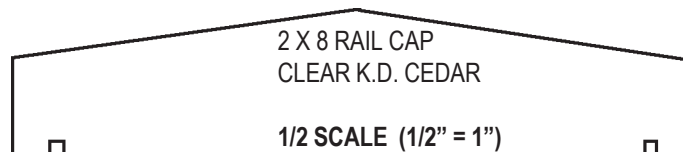

2 X 8 RAIL CAP
CLEAR K.D. CEDAR

1/2 SCALE (1/2" = 1")

MDF MOULDINGS

PRE-PRIMED UNLESS NOTED



BULLNOSE CASING
5/8 X 2-1/4

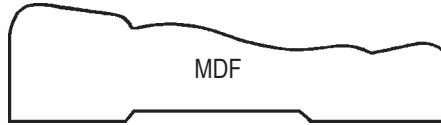

COLONIAL CASING
9/16 X 2-1/4

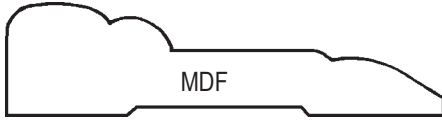

MOLDED CASING
9/16 X 2-1/4



MDF BEADED / FLUTED REVERSIBLE CASING---- 11/16 X 3-1/4

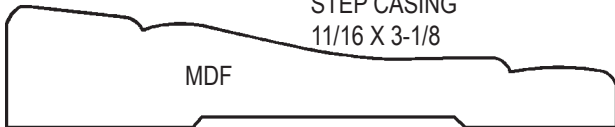

STEP CASING
11/16 X 3-1/8



MDF O.G. BASE
1/2 X 3-1/4



MDF O.G. BASE
1/2 X 2-1/4



MDF

O.G. BASE
1/2 X 5-1/4



MDF

COLONIAL BASE
9/16 X 5-1/4

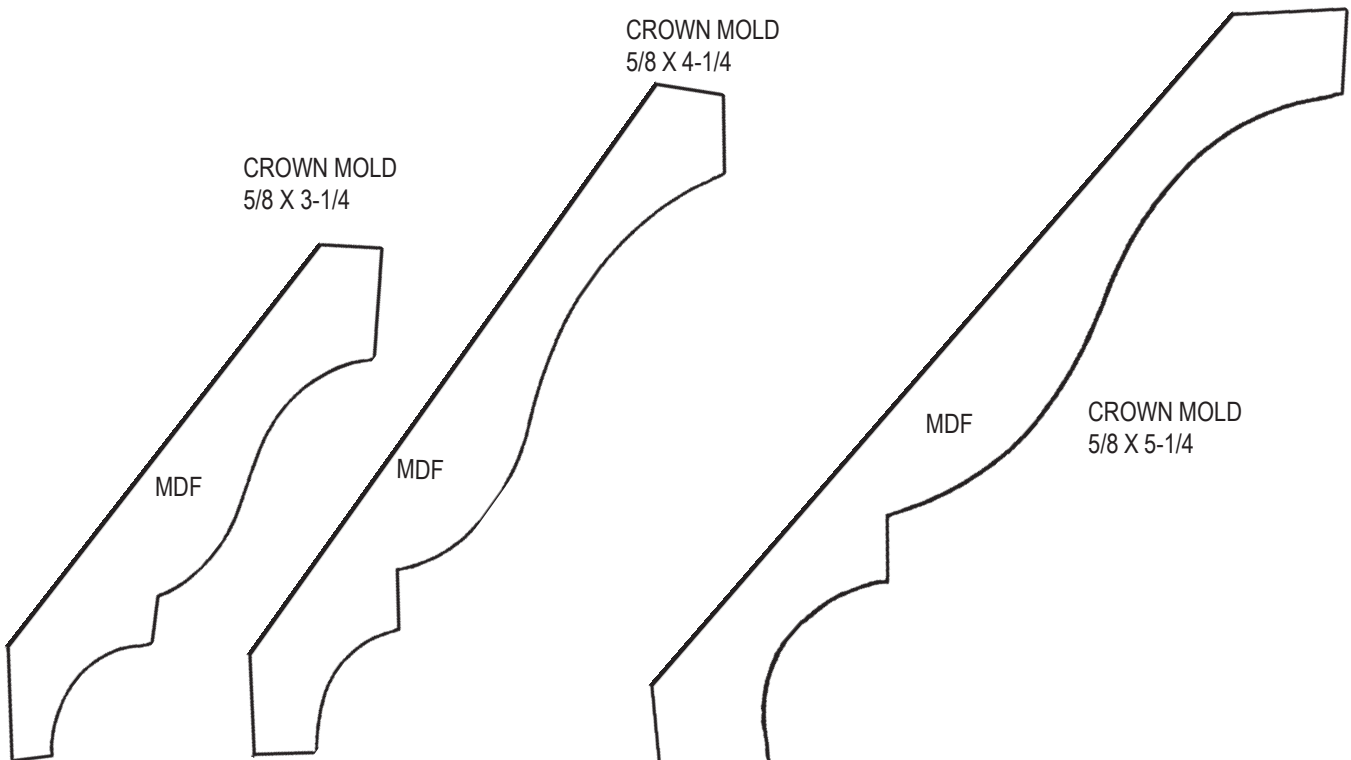

CROWN MOLD
5/8 X 4-1/4

CROWN MOLD
5/8 X 3-1/4

MDF CROWN MOLD
5/8 X 5-1/4

RED OAK MOULDINGS (WHITE OAK BASESHOE)

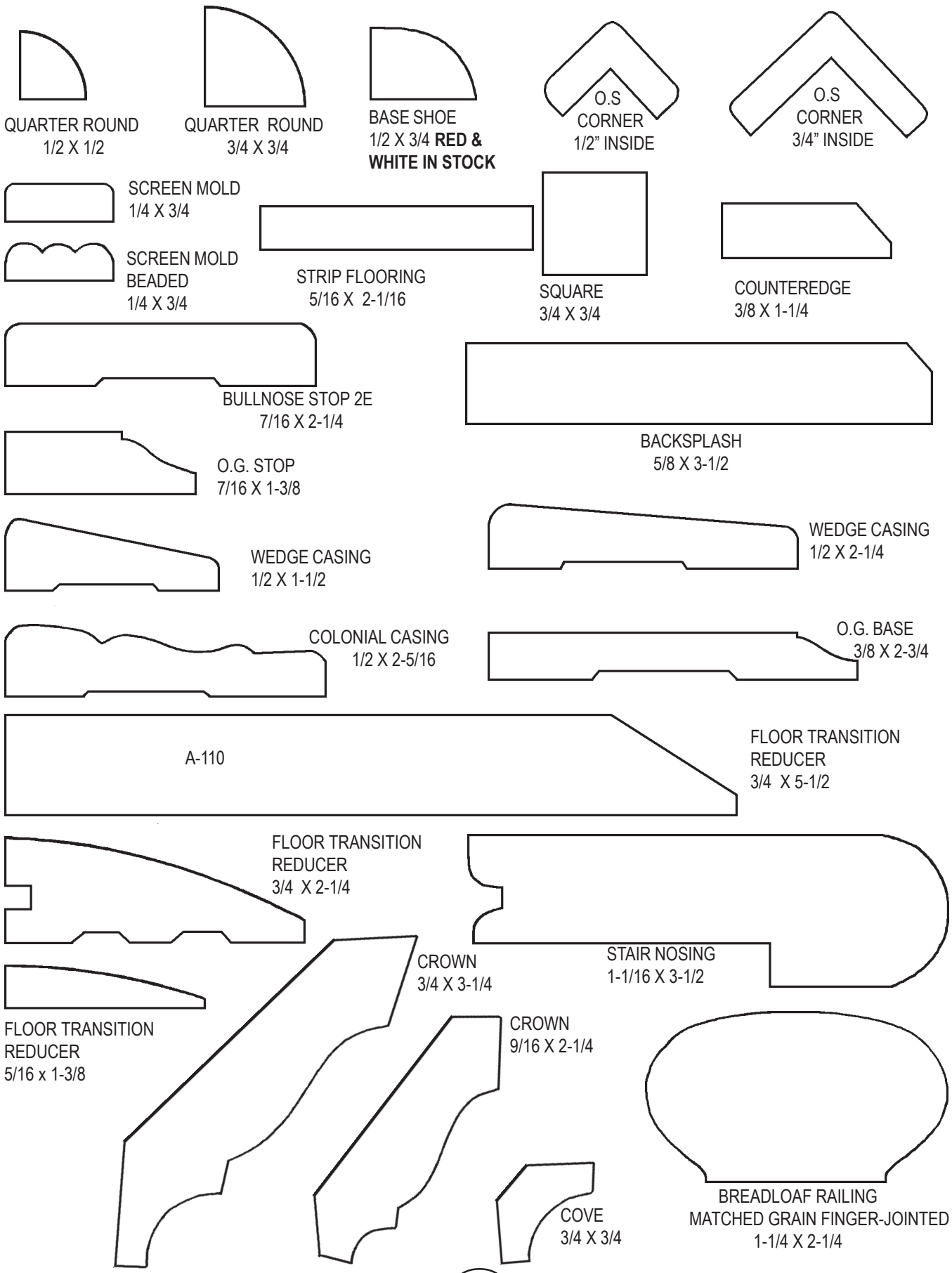

MAHOGANY MOULDINGS

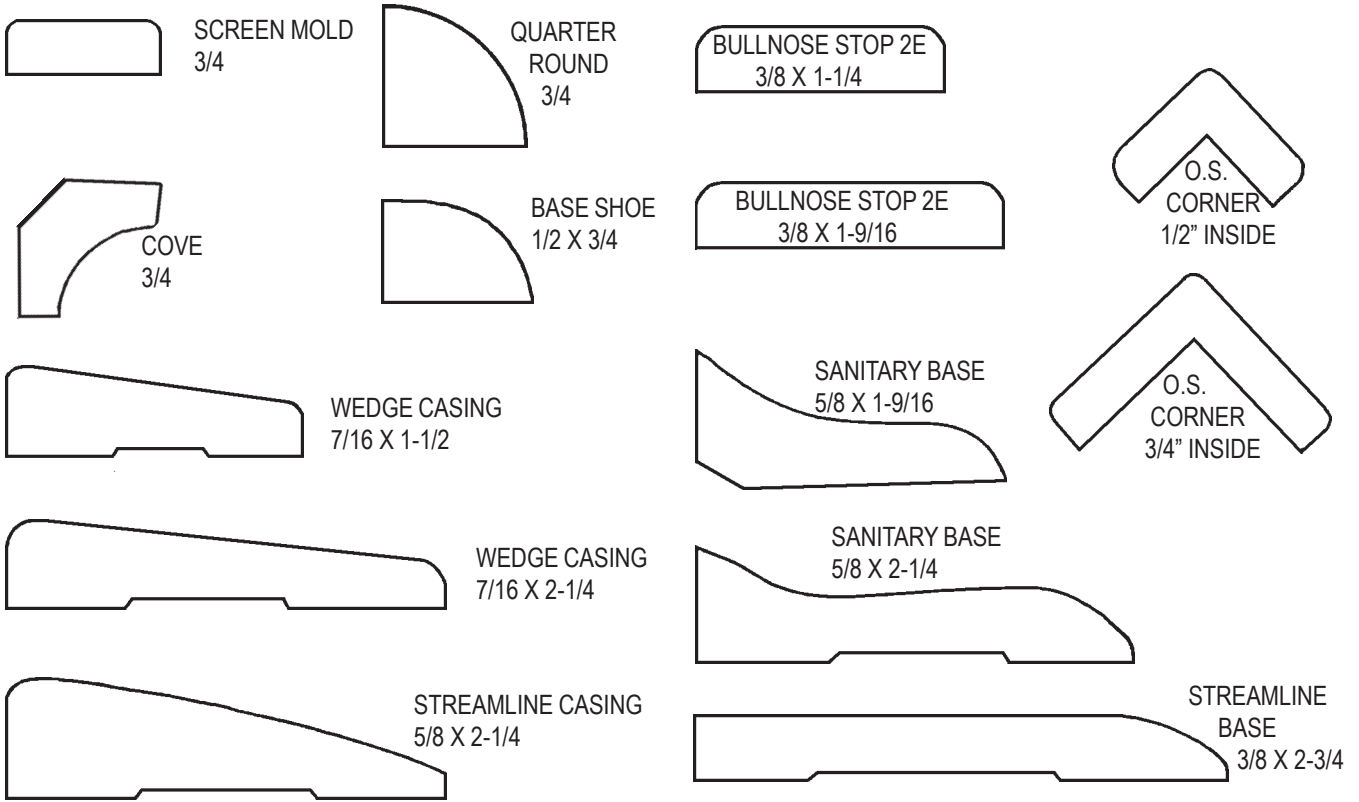

MAPLE MOULDINGS

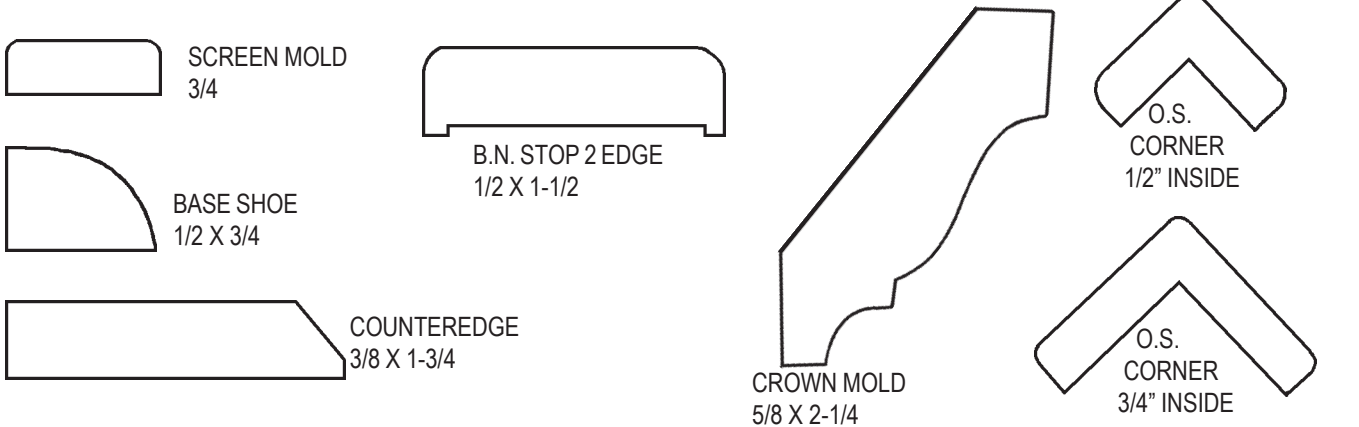

TEAK MOULDINGS

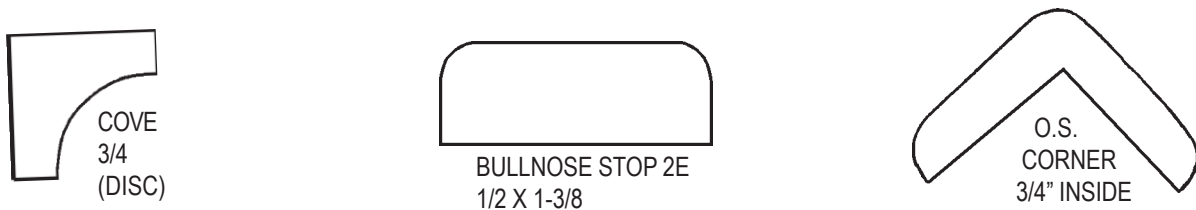

NOTES

NOTES
